Starting system





Contents	Pages			
	Silver Spirit Mulsanne	Silver Spur	Mulsanne Turbo	Corniche
Wiring diagram and component location	M4-1	M4-1	—	—

Starting system

Contents	Pages					
	Silver Spirit Mulsanne	Silver Spur	Mulsanne Turbo	Bentley Eight	Bentley Turbo R	Corniche/ Continental
Silver Spirit, Silver Spur, and Mulsanne cars fitted with an ammeter shunt						
Component location	M4-3	M4-3	—	—	—	—
Wiring diagram	M4-5	M4-5	—	—	—	—
Cars prior to VIN * SCAZS0006GCX13860 * fitted with a starter inhibit circuit						
<i>Cars other than those conforming to a North American specification</i>						
Component location	M4-7	M4-7	M4-15	M4-7	M4-15	—
Wiring diagram	M4-9	M4-9	M4-17	M4-9	M4-17	—
<i>Cars conforming to a North American specification</i>						
Component location	M4-11	M4-11	—	—	—	—
Wiring diagram	M4-13	M4-13	—	—	—	—

From VIN *SCAZS0006GCX13860* (excluding Corniche/Continental) and with the exception of VIN *SCAZN0004FCH14000* to VIN *SCAZN0009FCH14025* inclusive, a new type of fuseboard is fitted incorporating Littell or Buss fuses (these fuses are not interchangeable with Bulgin type fuses).

Therefore when working to a wiring diagram or component location showing the earlier Bulgin type of fuse, reference must be made to the following table for its equivalent.

Circuits controlled	Bulgin fuse number	Littell or Buss fuse number and fuseboard identification	Fuse rating (amps)	Circuits controlled	Bulgin fuse number	Littell or Buss fuse number and fuseboard identification	Fuse rating (amps)
							
Cellular telephone when fitted	—	A1 - F2	4A	Rear window demister and mirror heaters	11	B4 - F3	20A
Cellular telephone when fitted	—	A2 - F2	10A	Reverse lamps, stoplamps, speed control, headlamp wash	10	B3 - F3	20A
Interior lamps	1	A6 - F2	10A	Direction indicators, headlamp flash, fuel door, horns control	14	B2 - F3	20A
Radio, panel illumination, ACU control	20	B1 - F2	10A	Cigar lighters, clock, aerial, fuel door	7	C4 - F3	20A
Radio amplifier when fitted	19	B2 - F2	10A	Engine cooling fan	2	C1 - F3	20A
Starter, ignition, fuel pump	27	B3 - F2	10A	Engine cooling fan	9	C1 - F3	20A
Instruments and warning lamps	28	B4 - F2	10A	Wipers and washers	5	B1 - F3	20A
ACU control	8	B5 - F2	10A	Spare	—	B6 - F3	20A
Spare	—	B6 - F2	10A	Fuel pump	13	B5 - F3	20A
L.H. Tail lamp	15	C1 - F2	10A	Horns	3	C3 - F3	20A
R.H. Tail lamp	22	C2 - F2	10A	Fog lamps when fitted	12	C6 - F3	20A
Parking lamps, number plate lamps, W.L. dim control	16	C3 - F2	10A	Air horns when fitted	4	C5 - F3	20A
L.H. Dip beam	24	C4 - F2	10A	Hazard warning	6	C2 - F3	20A
R.H. Dip beam	25	C5 - F2	10A				
Spare	—	C6 - F2	10A				
Spare	—	A6 - F3	20A				

For fuse identification refer to Section M1, General information, page M1-3.





Starting system

Contents	Pages					
	Silver Spirit Mulsanne	Silver Spur	Mulsanne Turbo	Bentley Eight	Bentley Turbo R	Corniche/ Continental
Silver Spirit, Silver Spur, and Mulsanne cars fitted with an ammeter shunt						
Component location	M4-3	M4-3	—	—	—	—
Wiring diagram	M4-5	M4-5	—	—	—	—
Cars prior to VIN * SCAZS0006GCX13860 * fitted with a starter inhibit circuit						
<i>Cars other than those conforming to a North American specification</i>						
Component location	M4-7	M4-7	M4-15	M4-7	M4-15	—
Wiring diagram	M4-9	M4-9	M4-17	M4-9	M4-17	—
<i>Cars conforming to a North American specification</i>						
Component location	M4-11	M4-11	—	—	—	—
Wiring diagram	M4-13	M4-13	—	—	—	—

M4-2

From VIN *SCAZS0006GCX13860* (excluding Corniche/Continental) and with the exception of VIN *SCAZN0004FCH14000* to VIN *SCAZN0009FCH14025* inclusive, a new type of fuseboard is fitted incorporating Littell or Buss fuses (these fuses are not interchangeable with Bulgin type fuses).

Therefore when working to a wiring diagram or component location showing the earlier Bulgin type of fuse, reference must be made to the following table for its equivalent.

Circuits controlled	Bulgin fuse number 	Littell or Buss fuse number and fuseboard identification 	Fuse rating (amps)	Circuits controlled	Bulgin fuse number 	Littell or Buss fuse number and fuseboard identification 	Fuse rating (amps)
Cellular telephone when fitted	—	A1 - F2	4A	Rear window demister and mirror heaters	11	B4 - F3	20A
Cellular telephone when fitted	—	A2 - F2	10A	Reverse lamps, stoplamps, speed control, headlamp wash	10	B3 - F3	20A
Interior lamps	1	A6 - F2	10A	Direction indicators, headlamp flash, fuel door, horns control	14	B2 - F3	20A
Radio, panel illumination, ACU control	20	B1 - F2	10A	Cigar lighters, clock, aerial, fuel door	7	C4 - F3	20A
Radio amplifier when fitted	19	B2 - F2	10A	Engine cooling fan	2	C1 - F3	20A
Starter, ignition, fuel pump	27	B3 - F2	10A	Engine cooling fan	9	C1 - F3	20A
Instruments and warning lamps	28	B4 - F2	10A	Wipers and washers	5	B1 - F3	20A
ACU control	8	B5 - F2	10A	Spare	—	B6 - F3	20A
Spare	—	B6 - F2	10A	Fuel pump	13	B5 - F3	20A
L.H. Tail lamp	15	C1 - F2	10A	Horns	3	C3 - F3	20A
R.H. Tail lamp	22	C2 - F2	10A	Fog lamps when fitted	12	C6 - F3	20A
Parking lamps, number plate lamps, W.L. dim control	16	C3 - F2	10A	Air horns when fitted	4	C5 - F3	20A
L.H. Dip beam	24	C4 - F2	10A	Hazard warning	6	C2 - F3	20A
R.H. Dip beam	25	C5 - F2	10A				
Spare	—	C6 - F2	10A				
Spare	—	A6 - F3	20A				

For fuse identification refer to Section M1, General information, page M1-3.

Starting system

Cars fitted with an ammeter shunt

Component location

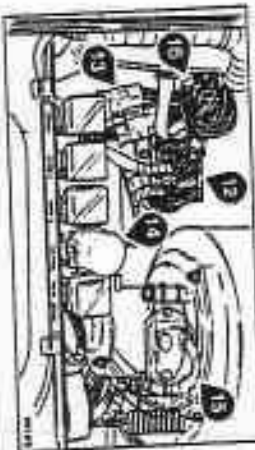
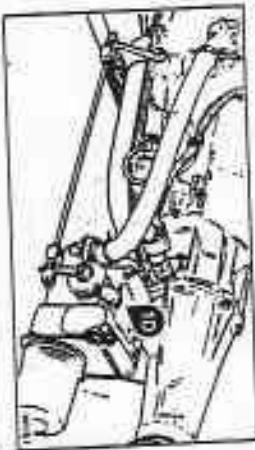
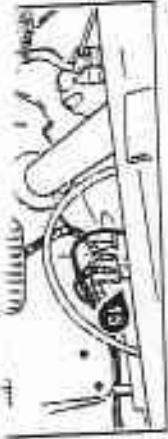
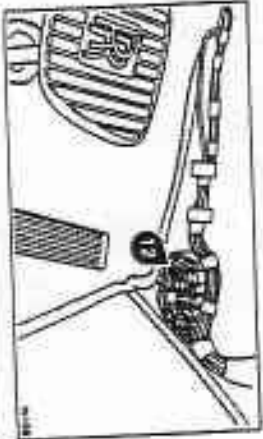
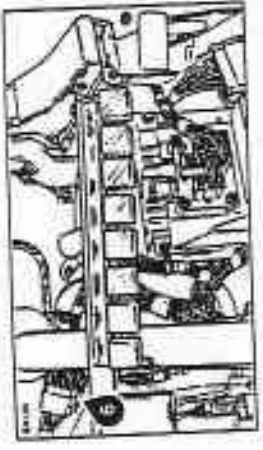
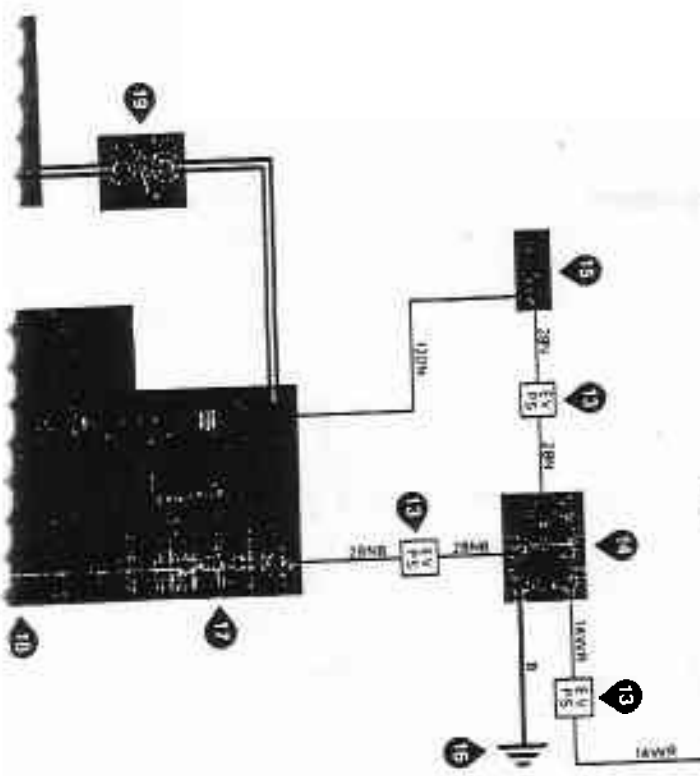
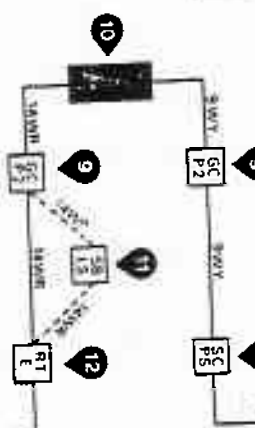
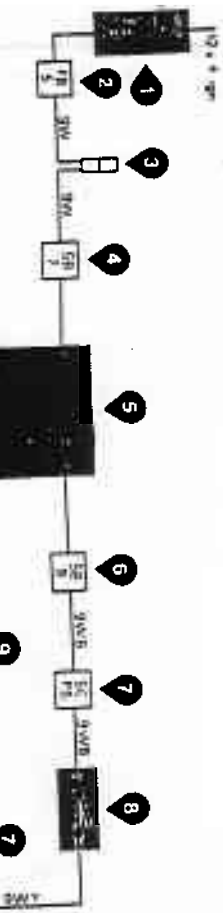

Starting system

Cars other than those conforming to a North American specification fitted with a starter inhibit circuit

Component location

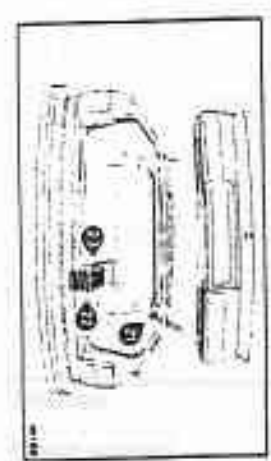
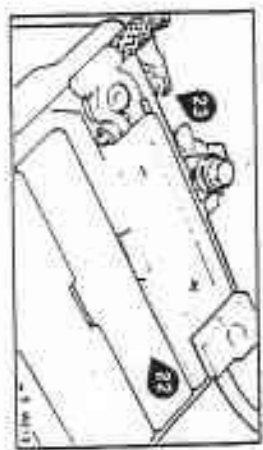
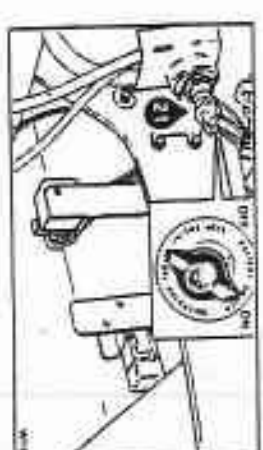
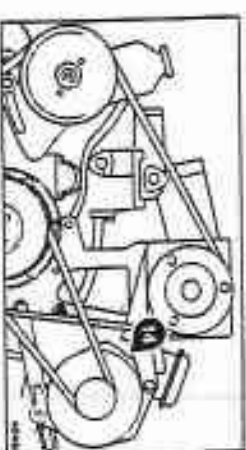
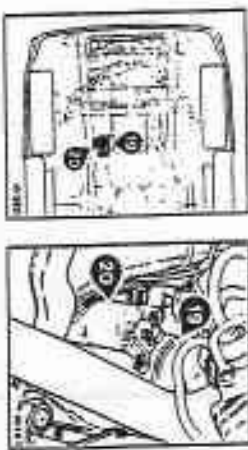
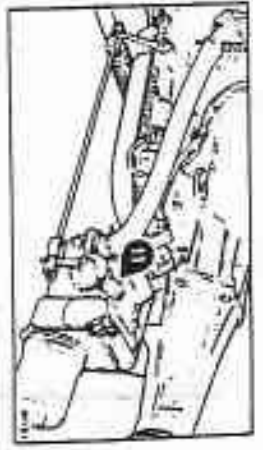
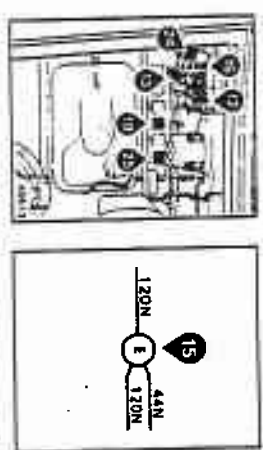
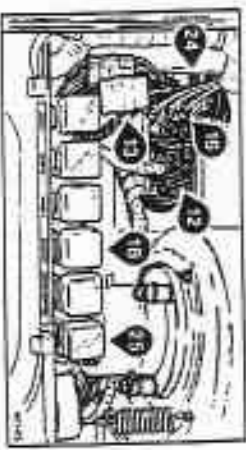
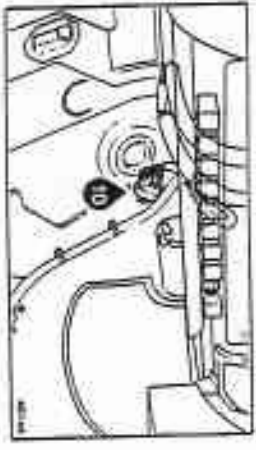
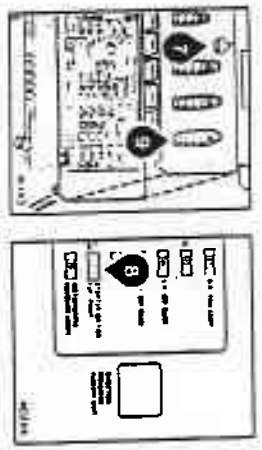
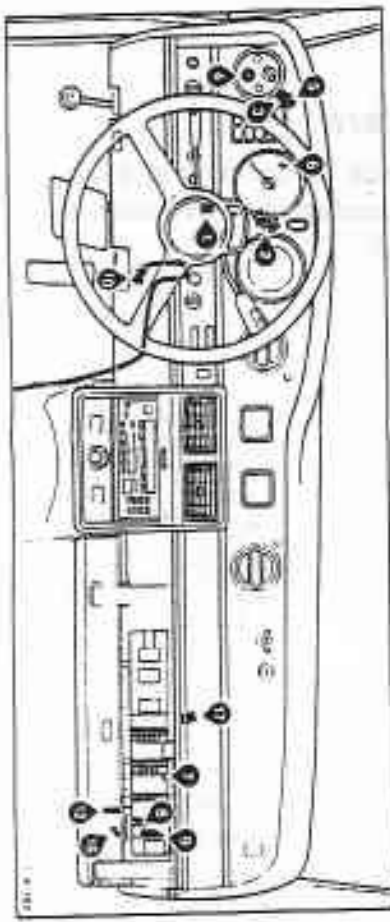
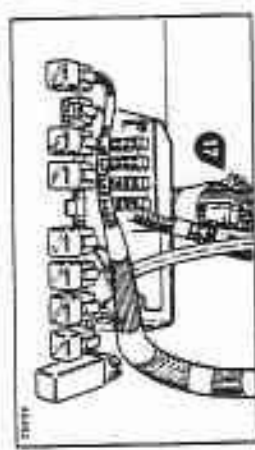
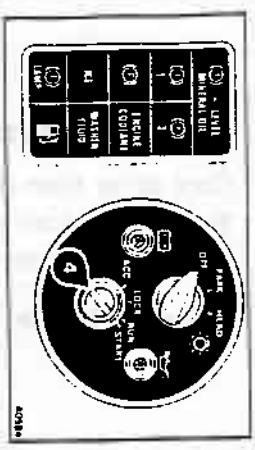
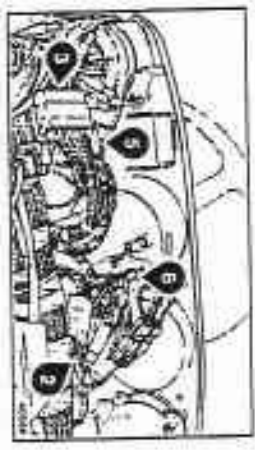
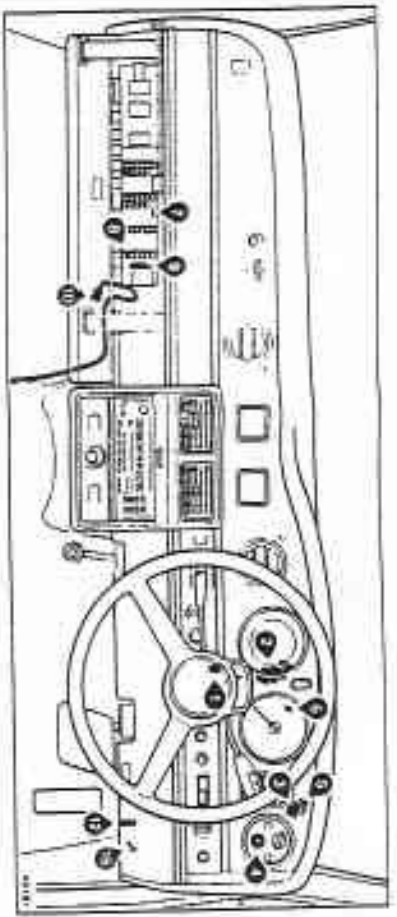

Starting system

Cars other than those conforming to a North American specification fitted with a starter inhibit circuit

Wiring diagram

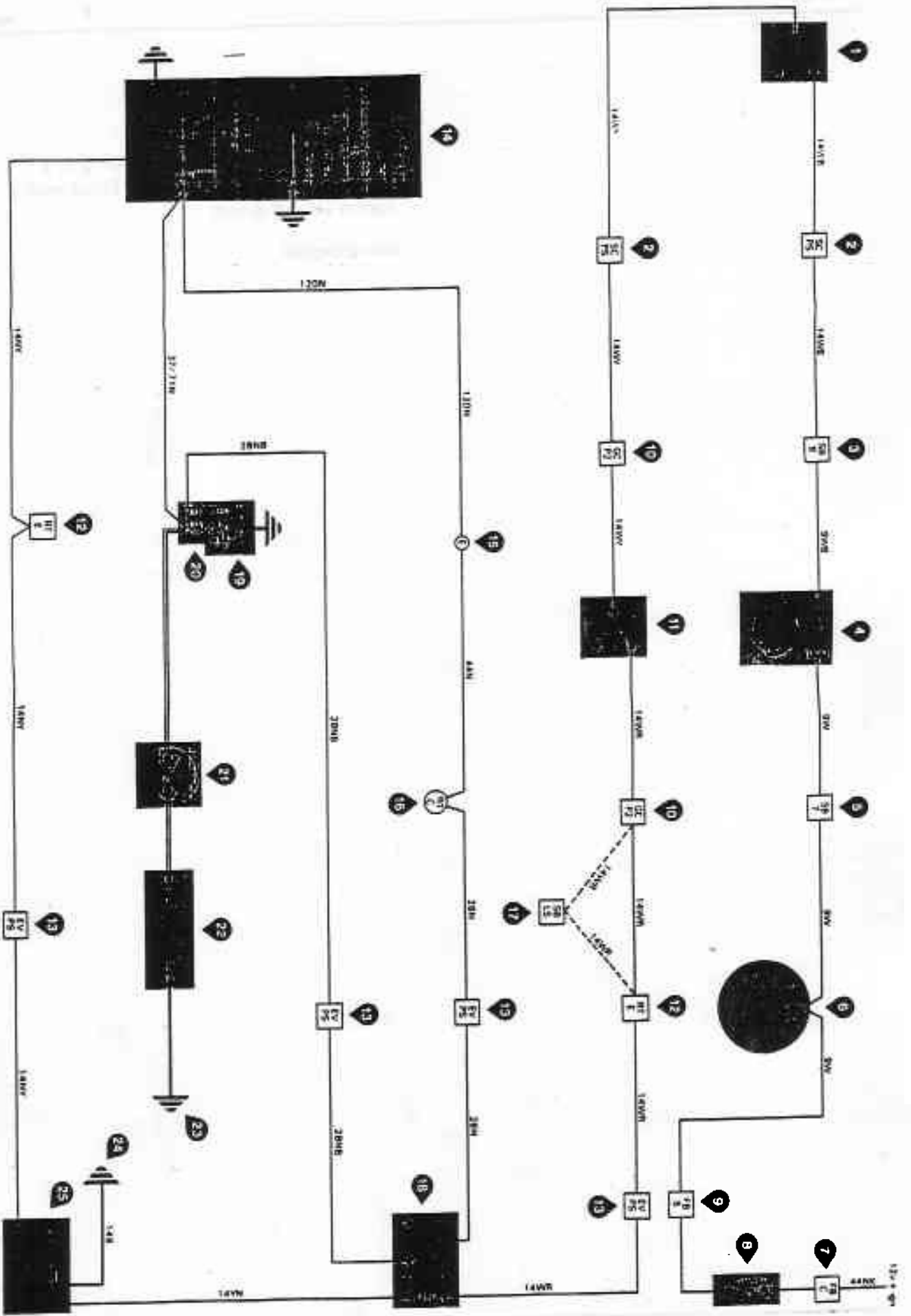

Starting system

Cars conforming to a North American specification fitted with a starter inhibit circuit

Component location

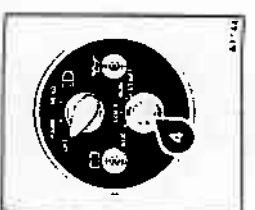
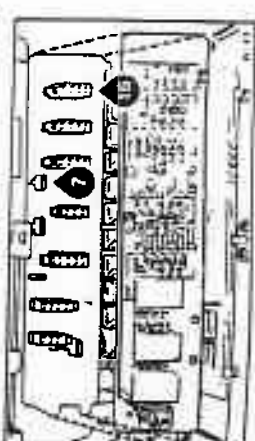
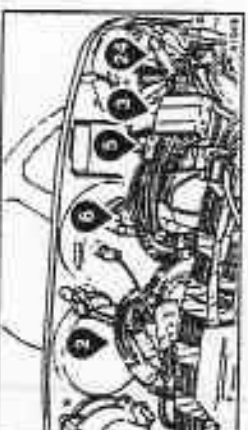
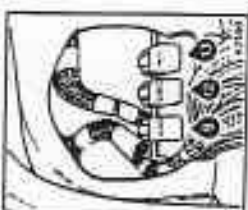
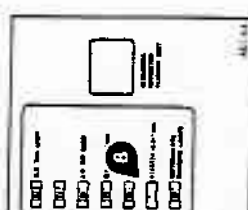
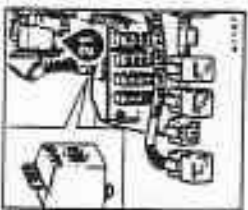
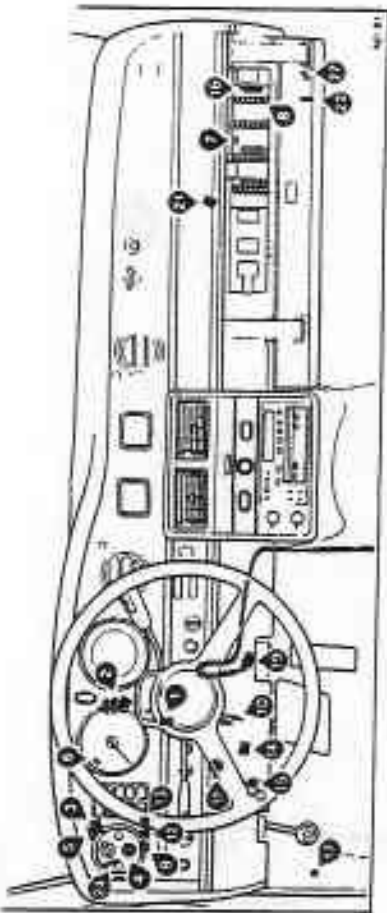
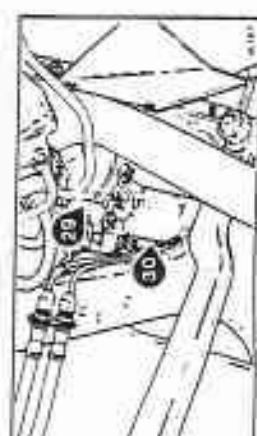
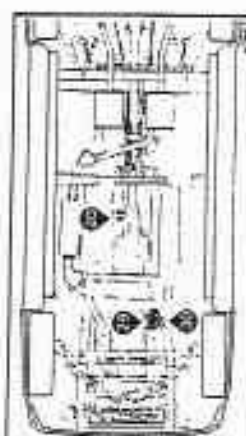
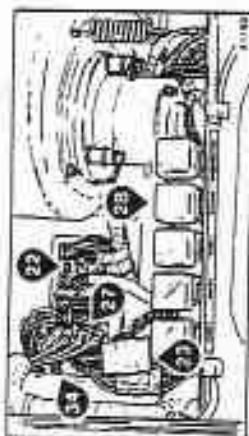
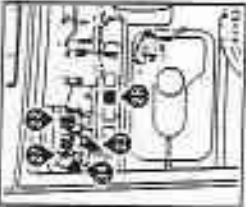
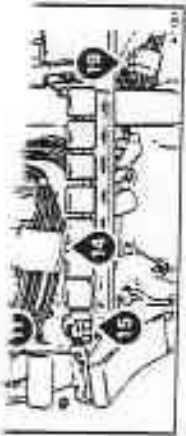
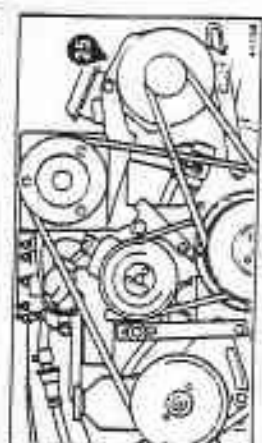
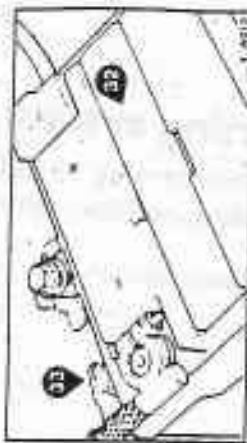
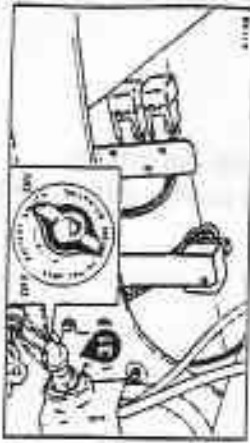
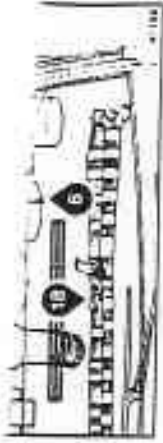

Starting system

Cars conforming to a North American specification fitted with a starter inhibit circuit

Wiring diagram

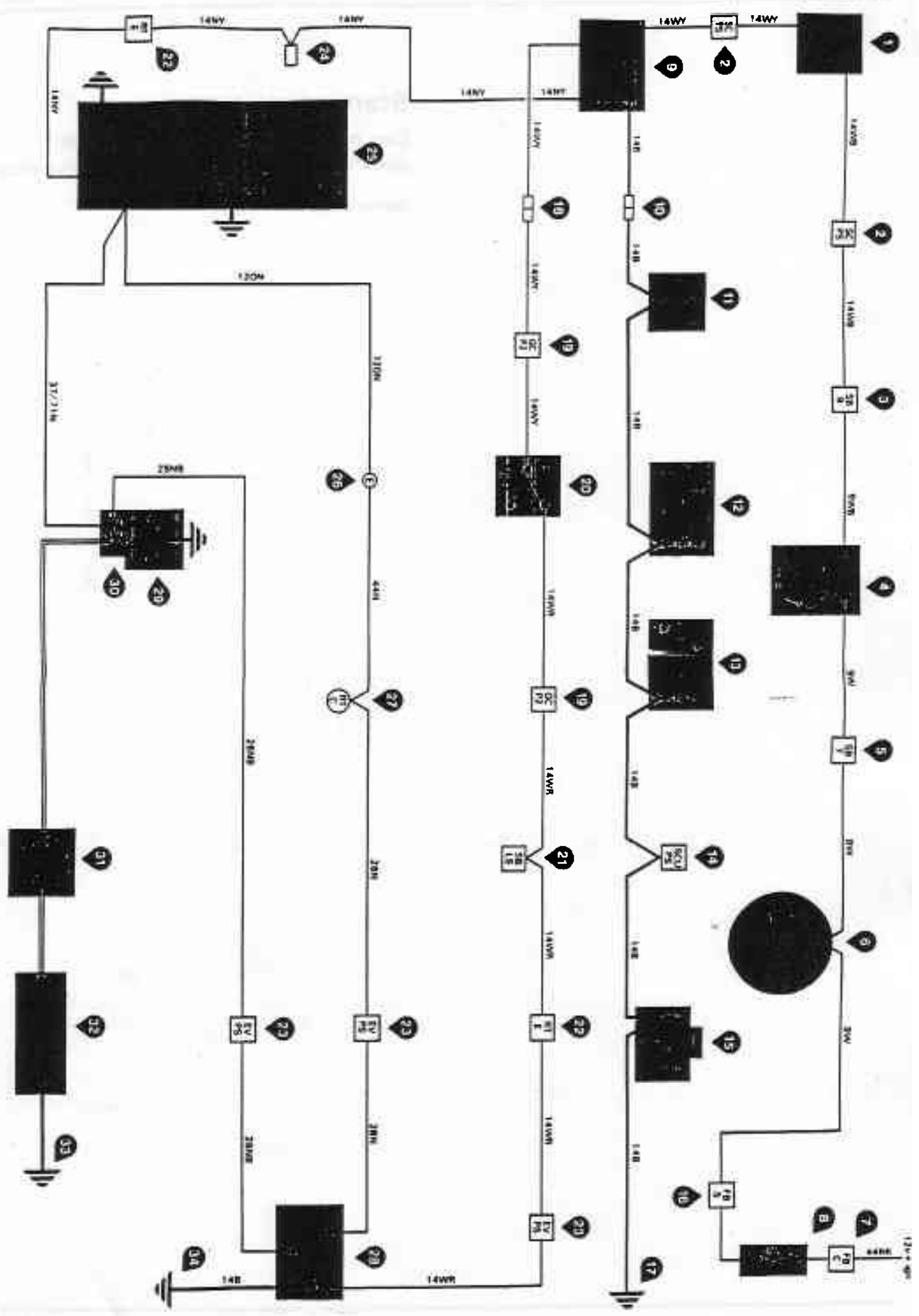

Starting system

Turbocharged cars fitted with a starter inhibit circuit

Component location

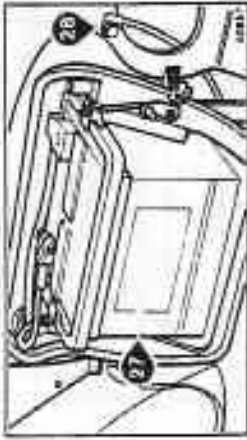
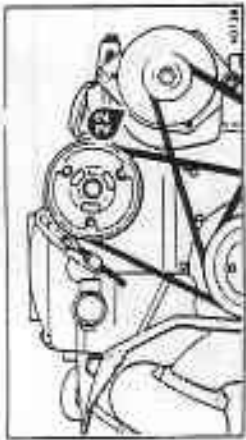
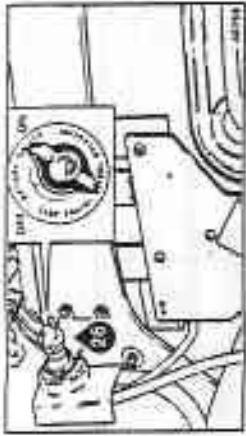

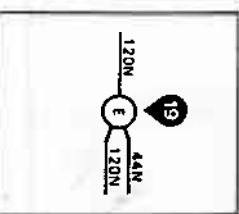
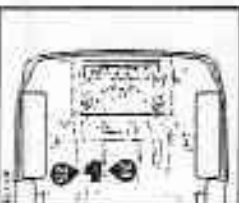
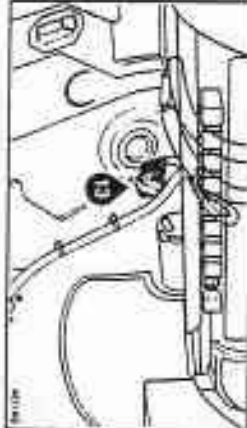
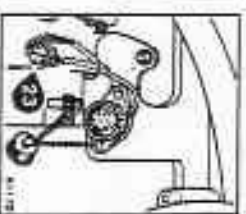
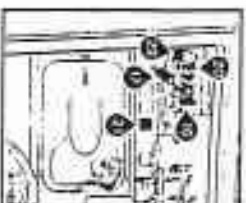
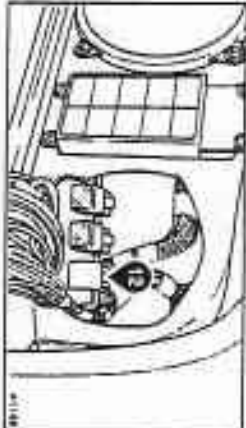
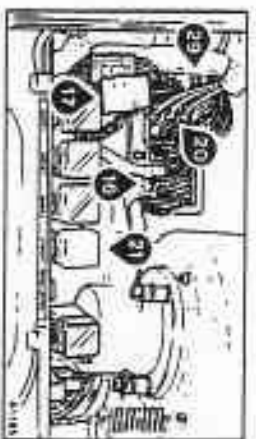
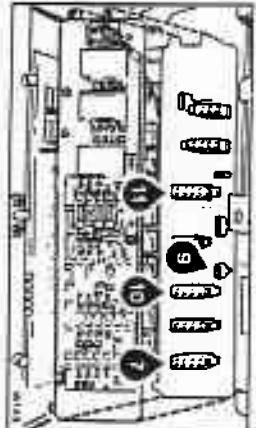
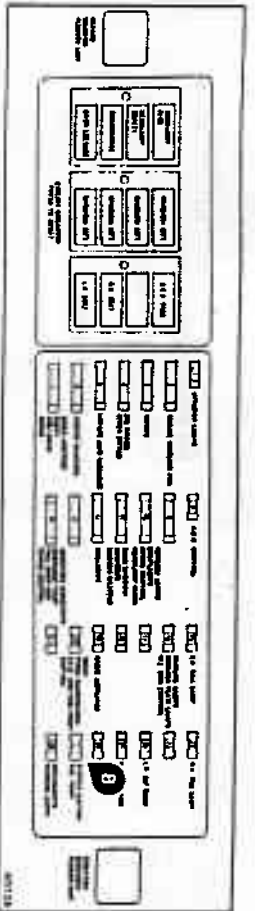
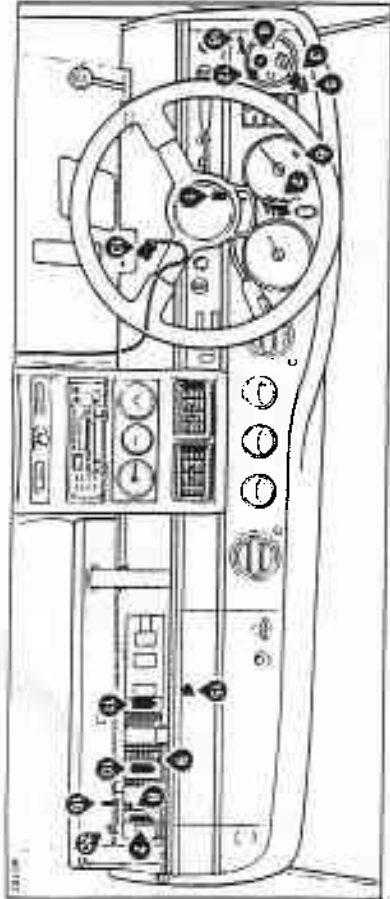
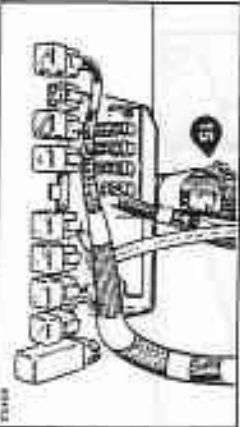
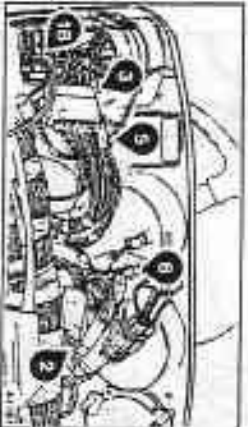
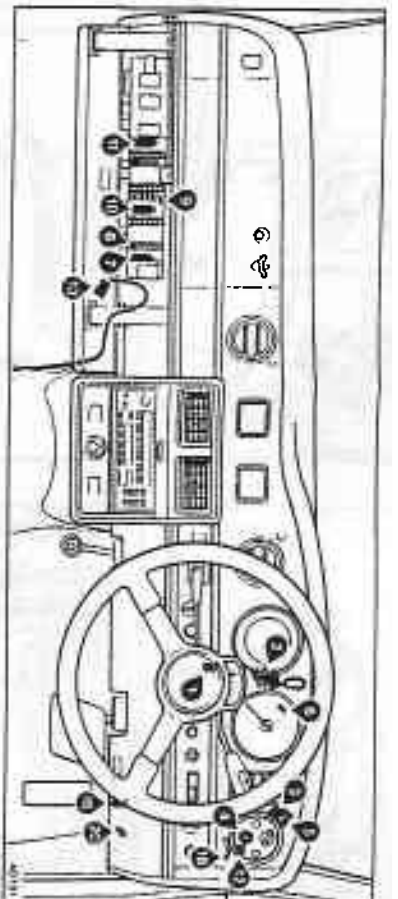

Starting system

Turbocharged cars fitted with a starter inhibit circuit

Wiring diagram

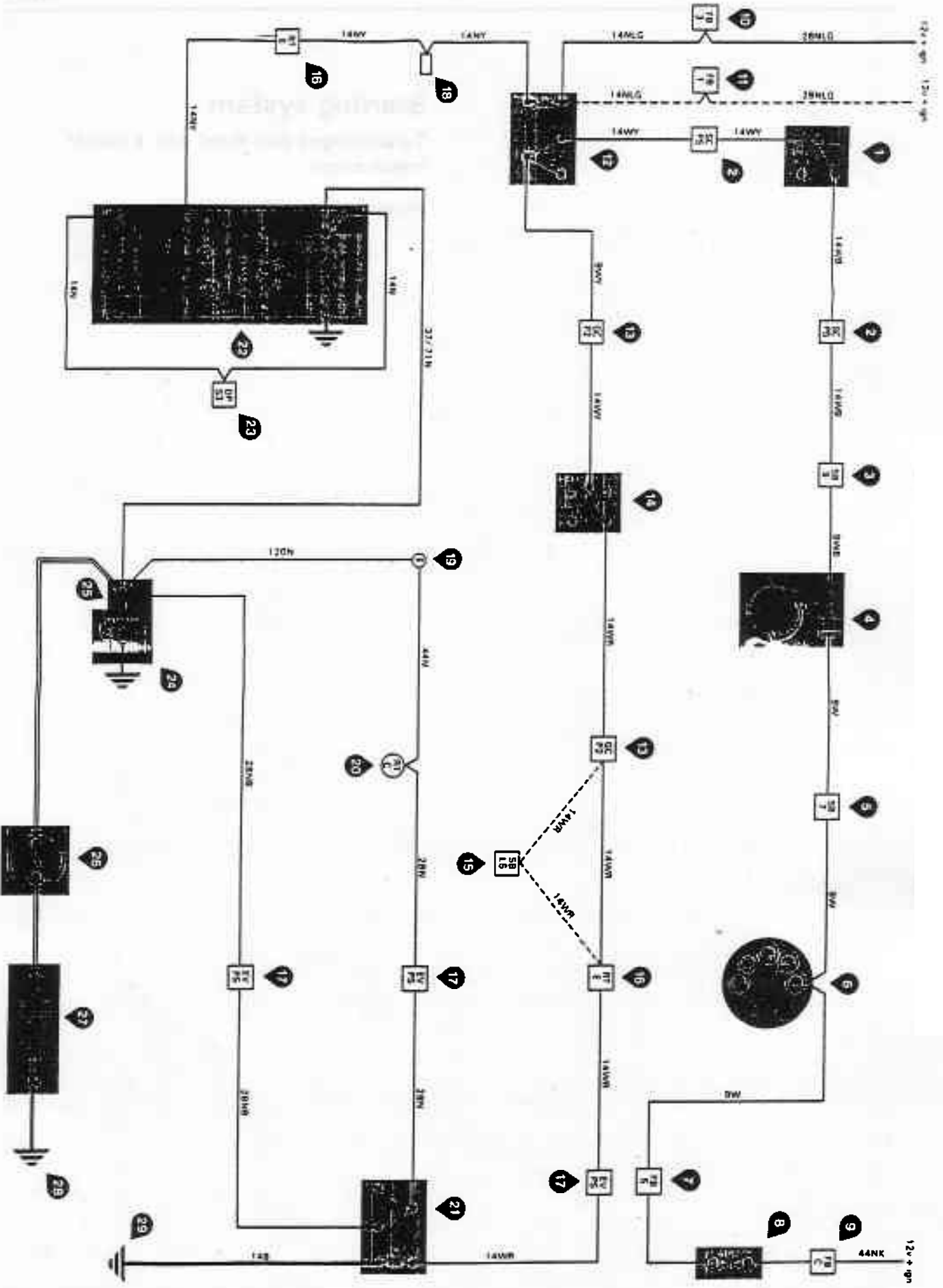

Ignition system

Contents	Pages					
	Silver Spirit Mulsanne	Silver Spur	Mulsanne Turbo	Bentley Eight	Bentley Turbo R	Corniche/ Continental
Ignition - To time	M5-3	M5-3	M5-3	M5-3	M5-3	M5-3
Ignition timing reference data	M5-3	M5-3	M5-3	M5-3	M5-3	M5-3

Ignition system

Ignition - To time (using a stroboscope)
 For cars conforming to an Australian, Japanese, Middle East, or North American specification refer to the appropriate section of Chapter U. For cars fitted with turbocharged engines, refer to Chapter K.

The ignition timing and engine speeds quoted in the following procedures apply to cars using 97 RON

octane fuel. For cars using a lower octane fuel refer to figure M5-1.

The ignition is timed on A1 cylinder which is located at the front, left-hand side of the engine (viewed from the front of the car).

1. Carry out the usual workshop safety precautions.
2. Ensure that the sparking plugs are in good

Model	Fuel (octane rating)	Engine rev/min	Ignition timing	Remarks
Silver Spirit Silver Spur Mulsanne (excluding Mulsanne Turbo and Bentley Turbo R) Bentley Eight		Static	5° btdc	Basic initial setting
	97 RON (min)	2200	25° btdc	The hose from the vacuum capsule disconnected and blanked off.
		650	6°-10° btdc	
	94 RON (min)	650	22°-30° btdc	The hose from the vacuum manifold to air intake sensor disconnected at the sensor and connected to the vacuum capsule (using additional length of hose).
		2200	21° btdc	The hose from the vacuum capsule disconnected and blanked off.
	650	2°-6° btdc		
	90 RON (min)	2200	17° btdc	The hose from the vacuum capsule disconnected and blanked off.
		650	2° btdc-2° atdc	
	650	10° -18° btdc	The hose from the vacuum manifold to air intake sensor disconnected at the sensor and connected to the vacuum capsule (using additional length of hose).	
Corniche/ Continental		Static	5° btdc	Basic initial setting
	97 RON (min)	2100	20° btdc	The hose from the vacuum capsule disconnected and blanked off.
	94 RON (min)	2100	20° btdc	
	90 RON (min)	2100	16° btdc	
On Corniche cars produced prior to either *SCBYD0008BCH02837* (cars conforming to the United Kingdom specification) or *SCAZD0004CCX05230* (cars other than those conforming to United Kingdom specifications) the use of low octane fuel necessitates a modification to the distributor vacuum advance signal and throttle damper jack hoses.				
Turbocharged cars	Refer to Chapter K			
Note For information on cars produced to an Australian, Japanese, Middle East, and North American specification refer to the appropriate section of Chapter U.				

Fig. M5-1 Ignition timing reference data

condition, clean or renew as necessary, the sparking plug gap should be set to 0.76 mm (0.031 in).
 3. Run the engine until normal operating temperature is reached and the choke fast-idle is off.

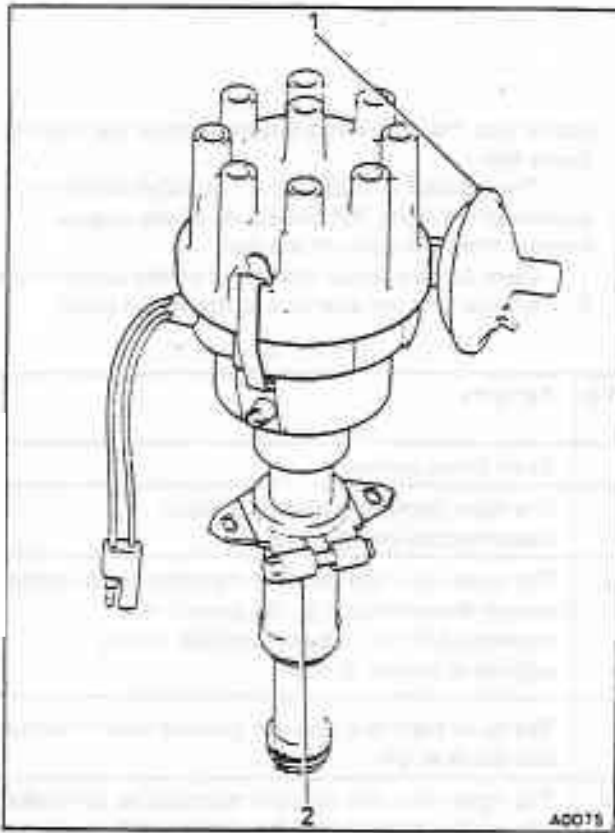

Fig. M5-2 Distributor

- 1 Vacuum capsule
- 2 Distributor clamp bolt

Stop the engine.

- 4. Connect a stroboscope and impulse tachometer in accordance with the manufacturer's instructions.
- 5. Disconnect the hose from the distributor vacuum capsule (see fig. M5-2). Blank off the hose.
- 6. Start the engine and set the engine speed to 2200 rev/min by adjusting the idle stop screw (see fig. M5-3). The speed should be set by approaching 2200 rev/min from a higher speed.
- 7. Direct the flashing light of the stroboscope onto the crankshaft damper and timing pointer (see fig. M5-4).

Slacken the distributor clamp bolt (see fig. M5-2) and rotate the distributor to set the timing at 25° btdc. Clockwise rotation of the distributor head advances the ignition timing and anti-clockwise rotation retards the ignition timing. After adjustment has been made, tighten the clamp screw and check to ensure that the timing is still 25° btdc.

- 8. Reset the engine speed to 650 rev/min by adjusting the idle stop screw.

Note

Operation 8 concludes the procedures for Corniche/Continental cars.

- 9. Check the ignition timing is between 6° btdc and 10° btdc.
- 10. Stop the engine.
- 11. Disconnect the vacuum manifold to air intake sensor hose, at the sensor. Connect this hose (using an additional length of hose) to the distributor vacuum capsule.
- 12. Start the engine and set the engine speed to 650 rev/min by adjusting the idle stop screw. Check that the ignition timing has now advanced to between 22° btdc and 30° btdc.
- 13. Remove the rubber hose fitted during Operation 11, and then re-connect the hoses to the intake sensor

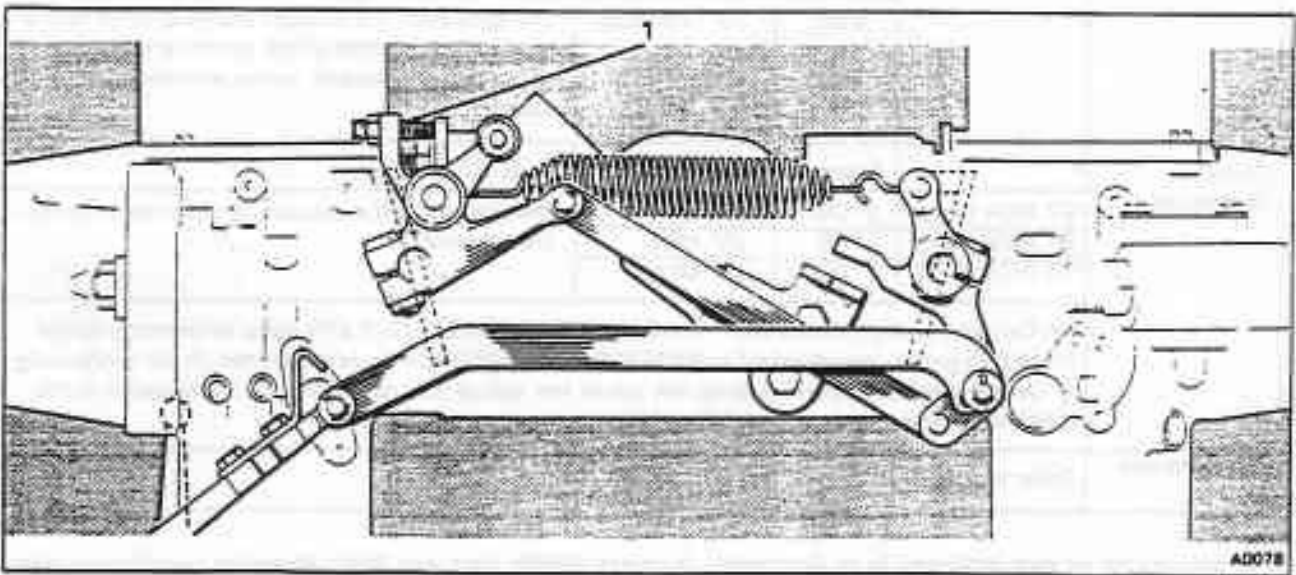

Fig. M5-3 Carburettor throttle linkage

- 1 Idle stop screw



Fig. M5-4 Position of ignition timing marks

and distributor vacuum capsule.

14. Start the engine and adjust the idle speed to 650 rev/min by adjusting the idle stop screw (see fig. M5-3).

15. Stop the engine and remove the test equipment.

Charging system

Contents

Pages

	Silver Spirit Mulsanne	Silver Spur	Mulsanne Turbo	Bentley Eight	Bentley Turbo R	Corniche/ Continental
Wiring diagram and component location	M6-1	M6-1	—	—	—	—

Charging System

Wiring diagram and component location

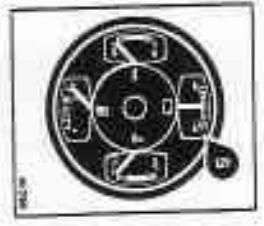
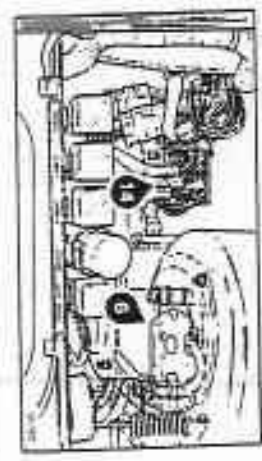
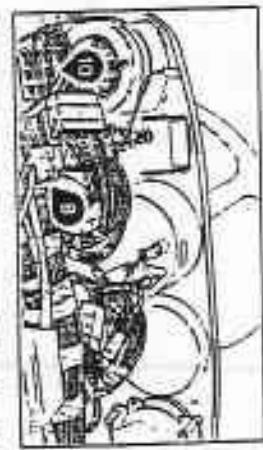
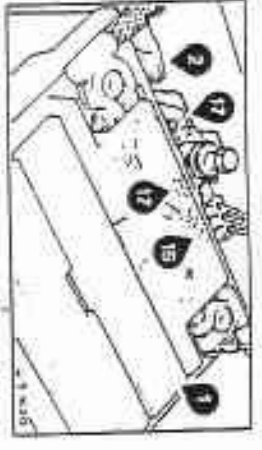
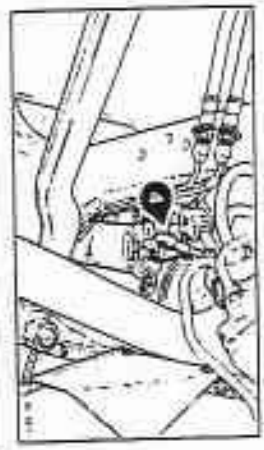
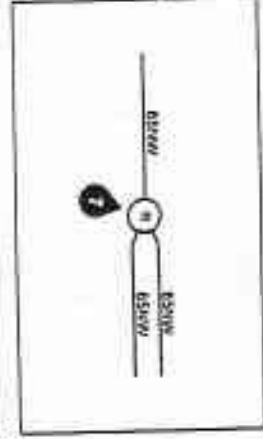
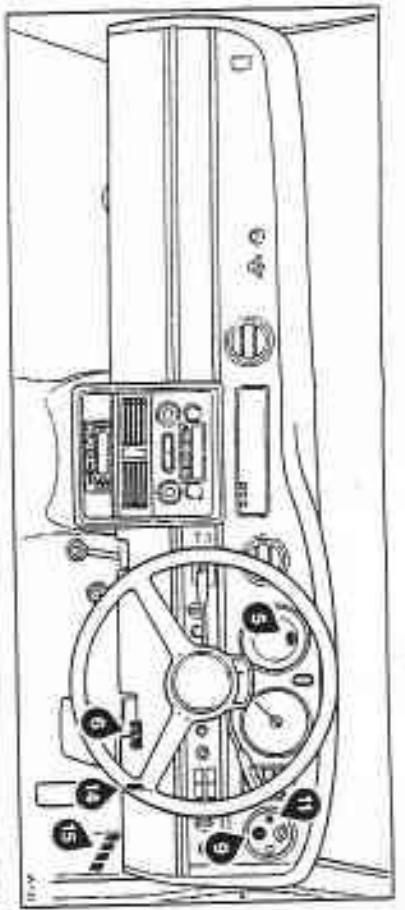
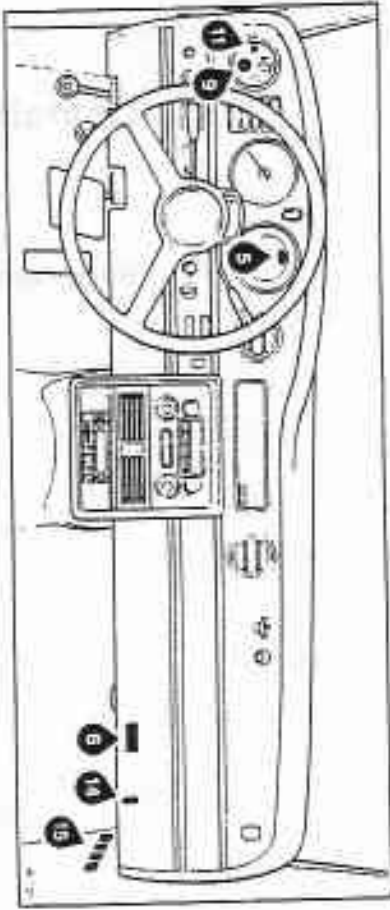
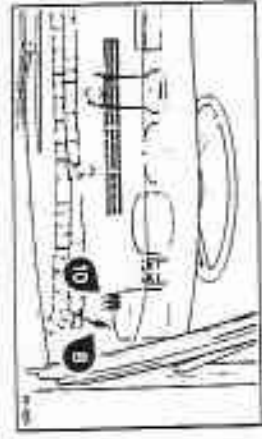
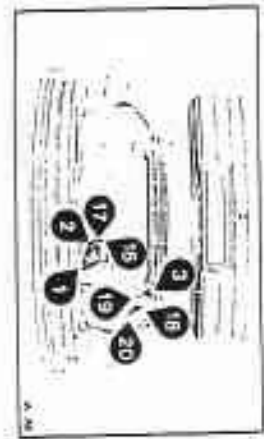
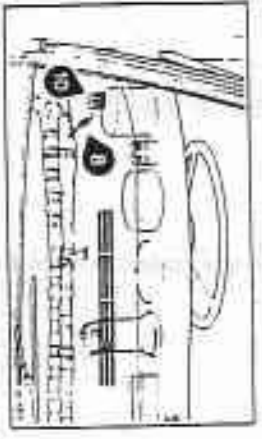
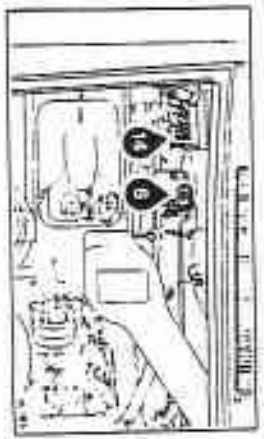

Charging System

Wiring diagram and component location

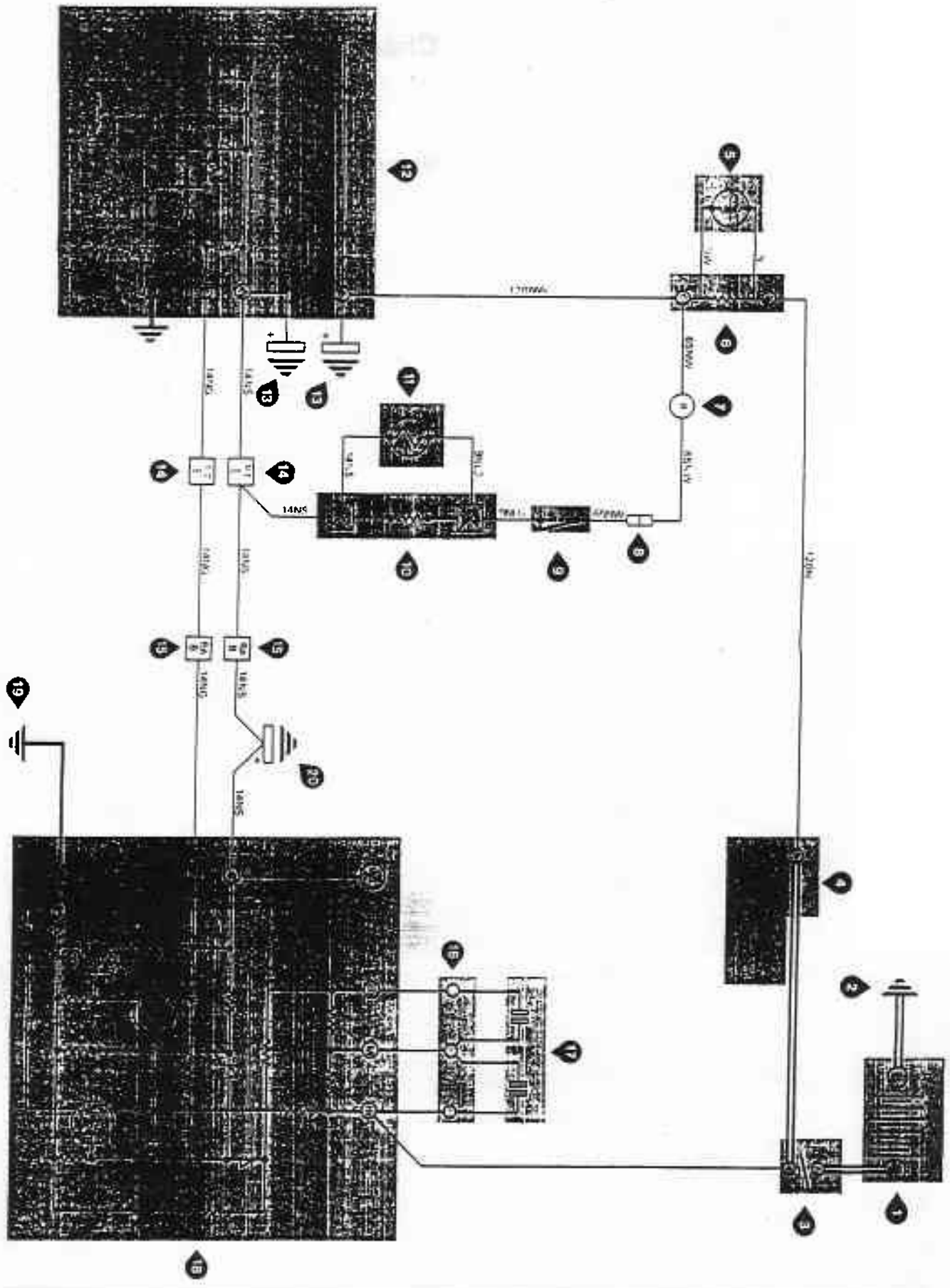

Gearchange actuator

Contents	Pages					
	Silver Spirit Mulsanne	Silver Spur	Mulsanne Turbo	Bentley Eight	Bentley Turbo R	Corniche/ Continental
Wiring diagram and component location	M7-3	M7-3	M7-3	M7-3	M7-3	M7-3
Operation of the system	M7-7	M7-7	M7-7	M7-7	M7-7	M7-7

Gearchange actuator

Wiring diagram and component location

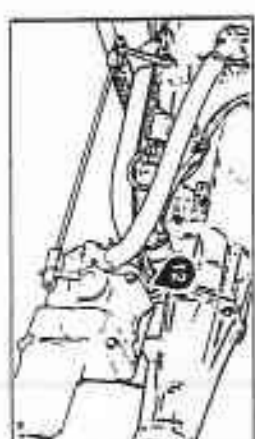
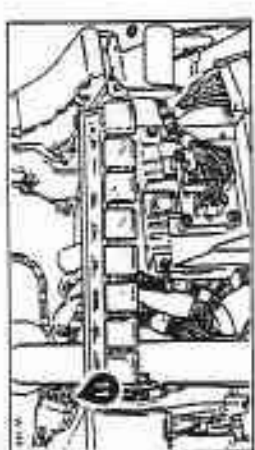
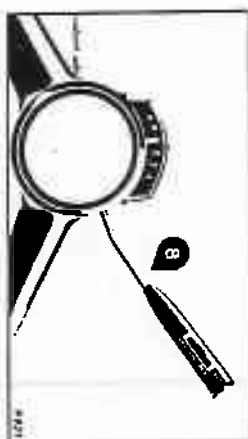
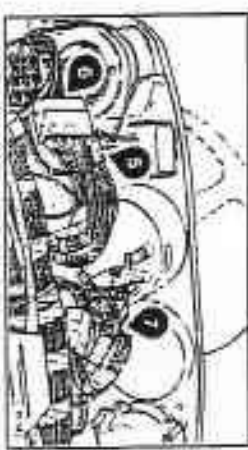
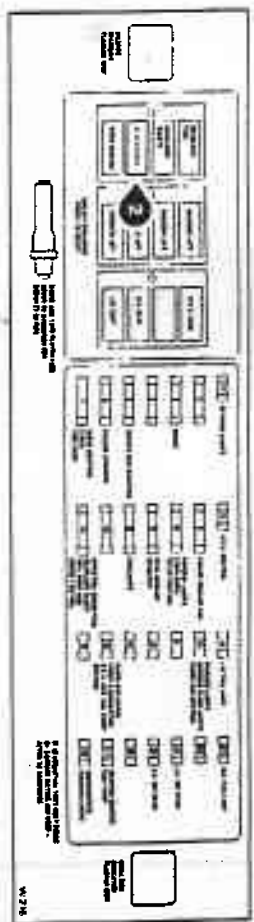
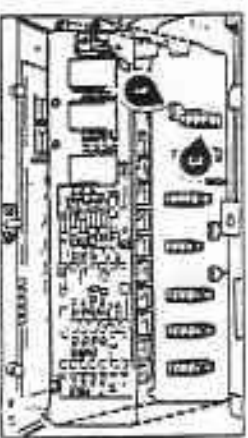
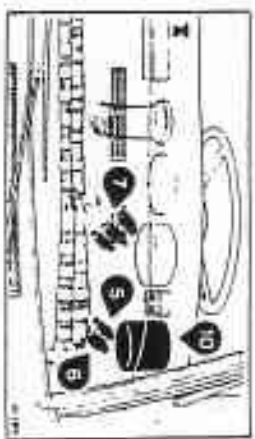
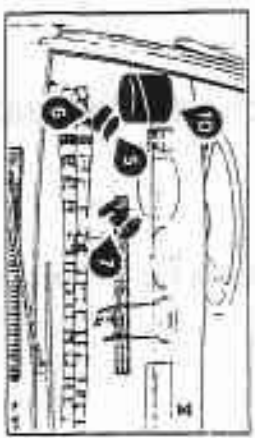
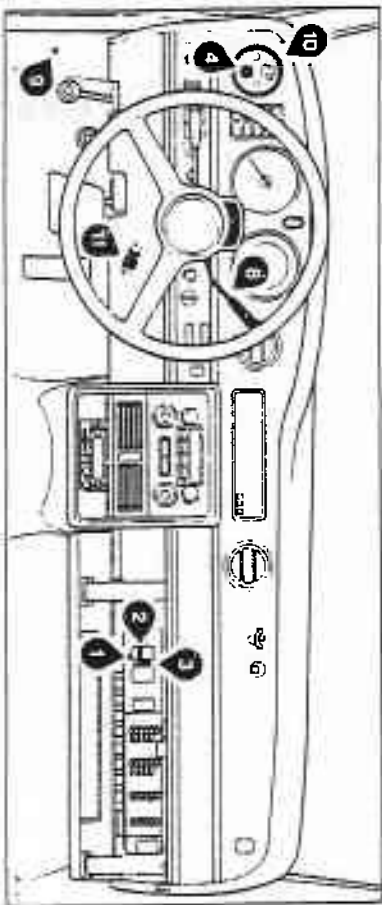
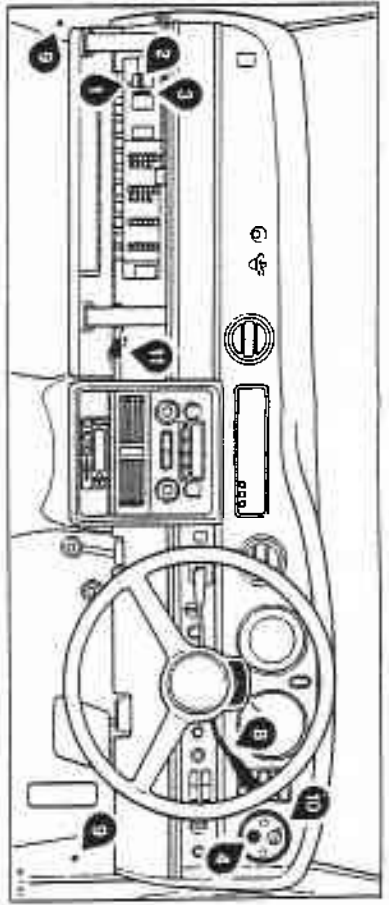

Gearchange actuator

Operation of the system

The gearchange actuator is mounted on a bracket secured to the transmission rear extension.

When the ignition key is turned to the RUN position and the gear range selector lever is moved to one of the gear range positions, current from the circuit breaker situated on the fuseboard flows via the gearchange actuator slip ring through relays to operate the actuator motor.

This causes the motor to rotate until the insulated portion of the slip ring (on the output shaft) is aligned

with the energised contact, thereby causing the motor to stop.

The output shaft, driven by a worm gear from the motor, drives an actuating lever (to select the required gear range), and also a cam.

The cam (dependent on gear range position) actuates micro-switches within the actuator to control auxiliary circuits.

The auxiliary circuits controlled by the micro-switches are the starter circuit (see Section M4), the reversing lamps circuit (see Section M14), and the

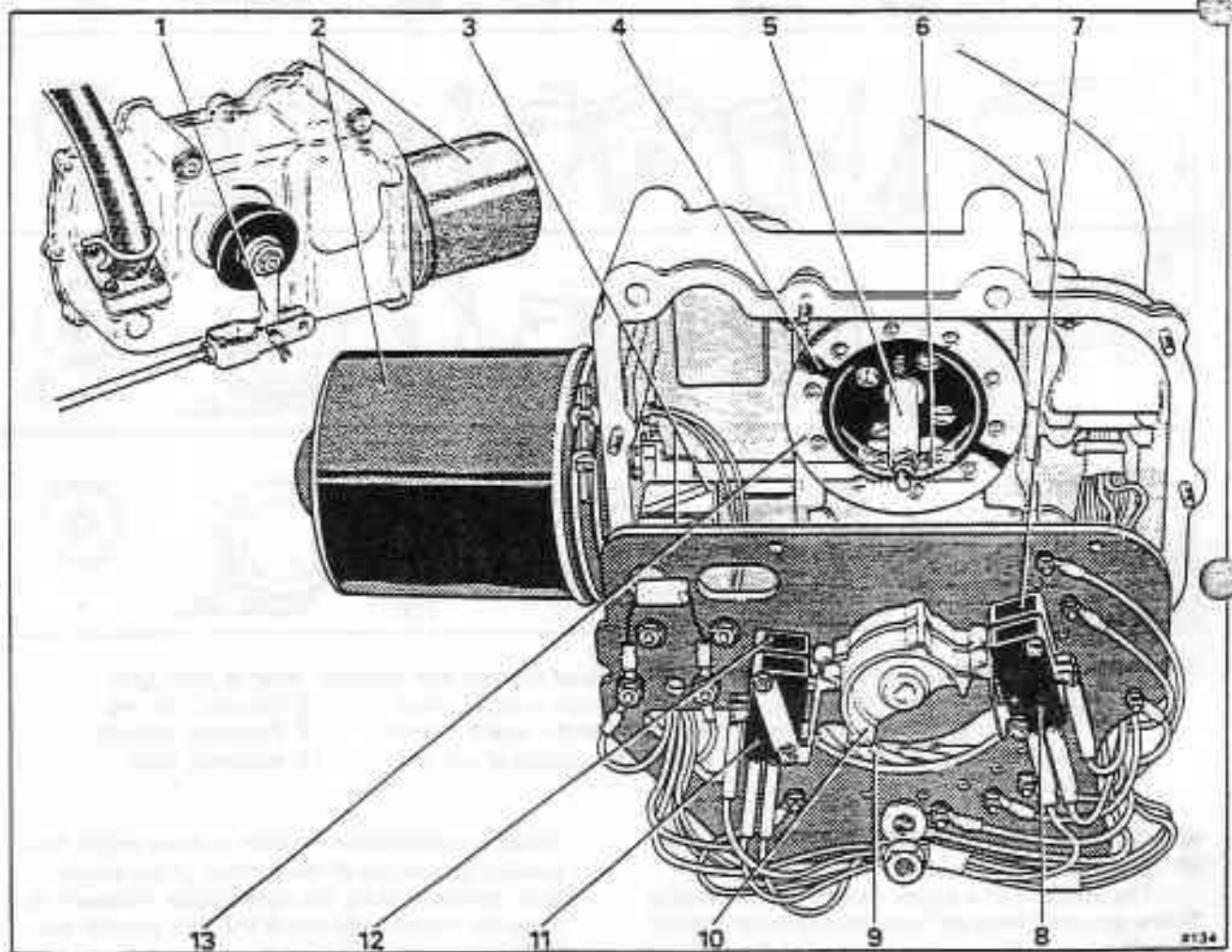

Fig. M7-1 Gearbox actuator

- | | | |
|----------------------------------|----------------------------------|-----------------------------------|
| 1 Actuating lever | 6 Worm gear | 11 Micro-switch - reversing lamps |
| 2 Motor | 7 Micro-switch - starter circuit | 12 Micro-switch - hood |
| 3 Relays | 8 Micro-switch - speed control | 13 Actuator slip ring |
| 4 Insulated portion of slip ring | 9 Contacts | |
| 5 Output shaft | 10 Cam | |

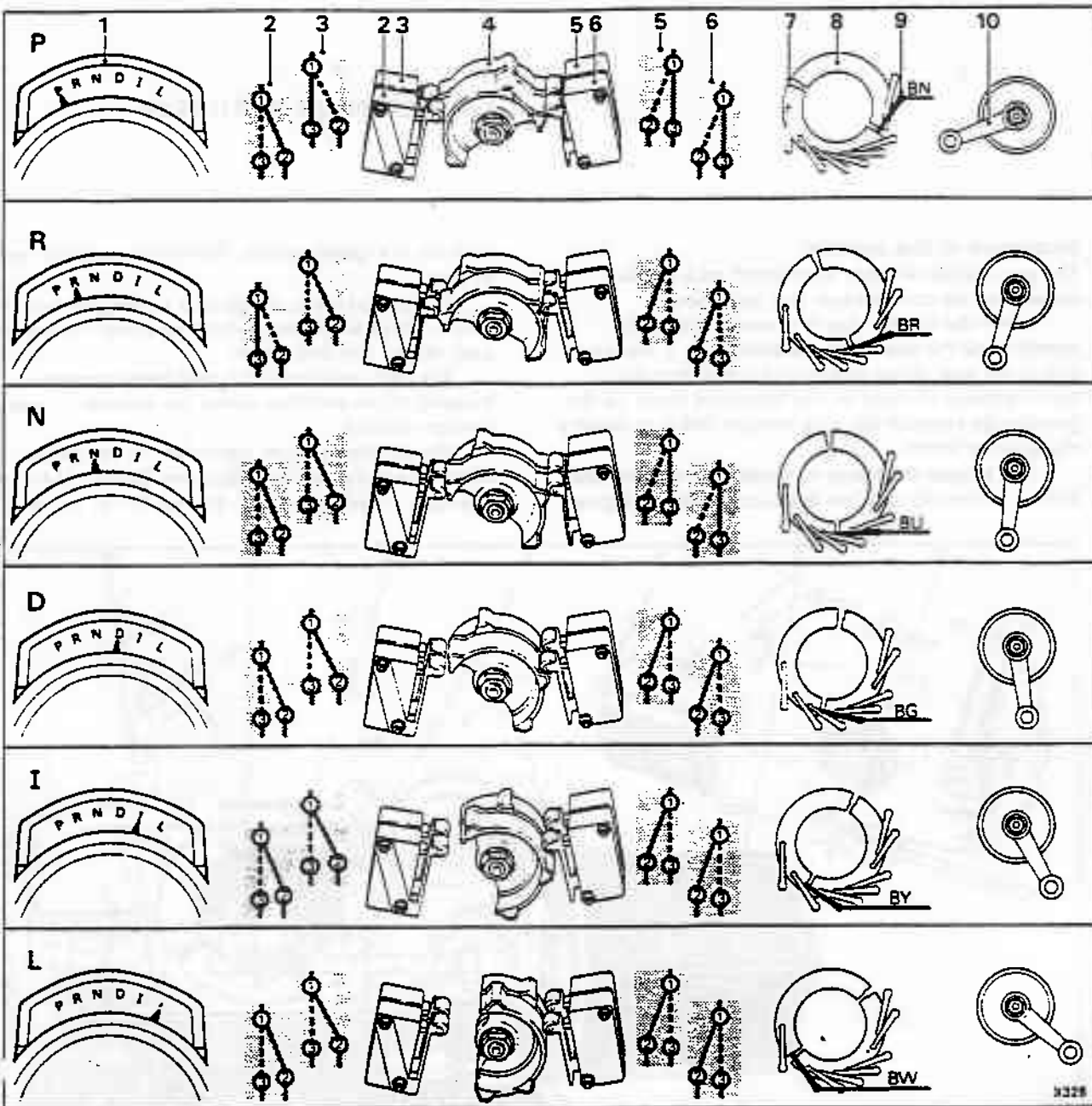

Fig. M7-2 Position of the cam, micro-switches, energised contact and actuator lever in each gear

- | | | |
|----------------------------------|----------------------------------|----------------------|
| 1 Gear range selector quadrant | 5 Micro-switch - starter circuit | 8 Actuator slip ring |
| 2 Micro-switch - reversing lamps | 6 Micro-switch - speed control | 9 Energised contact |
| 3 Micro-switch - hood | 7 Insulated portion of slip ring | 10 Actuating lever |
| 4 Cam | | |

speed control circuit (see Section M8), and the hood lift circuit on convertible cars.

The positions of the cam, micro-switch operating levers, actuating lever and also the energised contact (supplied by the gear range selector switch) in each gear range position are shown in figures M7 - 1 and M7 - 2.

With the ignition switched either on or off the transmission can be locked by moving the gear range selector lever to the Park position.

Removing the ignition key from the switchbox

causes the gearchange actuator to move to the Park position irrespective of the position of the selector lever, thereby locking the transmission. However, to move the transmission out of the Park position the ignition has to be switched on.

Note

The car can only be started with the gear range selector lever in either Park or Neutral position.

For further details of the actuator, including removal, how to dismantle, assembly, and how to fit the actuator refer to Chapter T Section T5.

Speed control system

Contents	Pages			
	Silver Spirit Mulsanne	Silver Spur	Mulsanne Turbo	Corniche
Wiring diagram and component location				
Right-hand drive cars	M8-1	M8-1	M8-1	—
Left-hand drive cars	M8-5	M8-5	M8-5	—
Operation of the system	M8-9	M8-9	M8-9	M8-9
Road test procedure	M8-10	M8-10	M8-10	M8-10
Electrical test and fault diagnosis	M8-11	M8-11	M8-11	M8-11

Speed control system

Contents	Pages					
	Silver Spirit Mulsanne	Silver Spur	Mulsanne Turbo	Bentley Eight	Bentley Turbo R	Comiche/ Continental
Cars prior to vehicle identification number *SCAZS42A3FCX12001*						
Right-hand drive cars						
Component location	M8-3	M8-3	M8-3	M8-3	—	M8-29
Wiring diagram	M8-5	M8-5	M8-5	M8-5	—	M8-31
Left-hand drive cars						
Component location	M8-7	M8-7	M8-7	M8-7	—	M8-29
Wiring diagram	M8-9	M8-9	M8-9	M8-9	—	M8-33
Operation of the system	M8-11	M8-11	M8-11	M8-11	—	M8-11
Road test procedure	M8-12	M8-12	M8-12	M8-12	—	M8-12
Electrical test and fault diagnosis	M8-13	M8-13	M8-13	M8-13	—	M8-13
Cars from vehicle identification number *SCAZS42A3FCX12001*						
Component location	M8-17	M8-17	M8-23	M8-17	M8-23	M8-35
Wiring diagram						
Right-hand drive cars	M8-19	M8-19	M8-25	M8-19	M8-25	M8-37
Left-hand drive cars	M8-21	M8-21	M8-27	M8-21	M8-27	M8-39

on VIN *SCAZS0006GCX13860* (excluding Corniche/Continental) and with the exception of VIN SCAZN0004FCH14000* to VIN *SCAZN0009FCH14025* inclusive, a new type of fuseboard is fitted incorporating Littell or Buss fuses (these fuses are not interchangeable with Bulgin type fuses).

Therefore when working to a wiring diagram or component location showing the earlier Bulgin type of fuse, reference must be made to the following table for its equivalent.

Circuits controlled	Bulgin fuse number	Littell or Buss fuse number and fuseboard identification	Fuse rating (amps)	Circuits controlled	Bulgin fuse number	Littell or Buss fuse number and fuseboard identification	Fuse rating (amps)
Cellular telephone when fitted	—	A1 - F2	4A	Rear window demister and mirror heaters	11	B4 - F3	20A
Cellular telephone when fitted	—	A2 - F2	10A	Reverse lamps, stoplamps, speed control, headlamp wash	10	B3 - F3	20A
Interior lamps	1	A6 - F2	10A	Direction indicators, headlamp flash, fuel door, horns control	14	B2 - F3	20A
Radio, panel illumination, ACU control	20	B1 - F2	10A	Cigar lighters, clock, aerial, fuel door	7	C4 - F3	20A
Radio amplifier when fitted	19	B2 - F2	10A	Engine cooling fan	2	C1 - F3	20A
Starter, ignition, fuel pump	27	B3 - F2	10A	Engine cooling fan	9	C1 - F3	20A
Instruments and warning lamps	28	B4 - F2	10A	Wipers and washers	5	B1 - F3	20A
ACU control	8	B5 - F2	10A	Spare	—	B6 - F3	20A
Spare	—	B6 - F2	10A	Fuel pump	13	B5 - F3	20A
L.H. Tail lamp	15	C1 - F2	10A	Horns	3	C3 - F3	20A
R.H. Tail lamp	22	C2 - F2	10A	Fog lamps when fitted	12	C6 - F3	20A
Parking lamps, number plate lamps, W.L. dim control	16	C3 - F2	10A	Air horns when fitted	4	C5 - F3	20A
L.H. Dip beam	24	C4 - F2	10A	Hazard warning	6	C2 - F3	20A
R.H. Dip beam	25	C5 - F2	10A				
Spare	—	C6 - F2	10A				
Spare	—	A6 - F3	20A				

For fuse identification refer to Section M1, General information, page M1-3.

Speed control system

Right-hand drive cars

Wiring diagram and component location

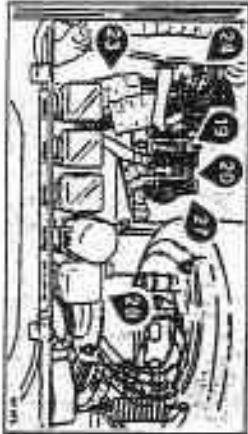
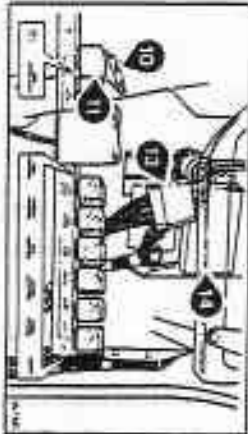
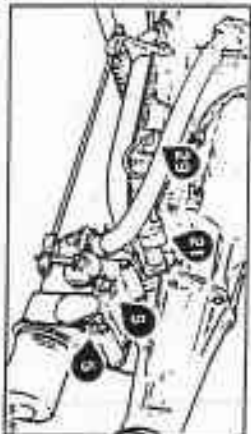
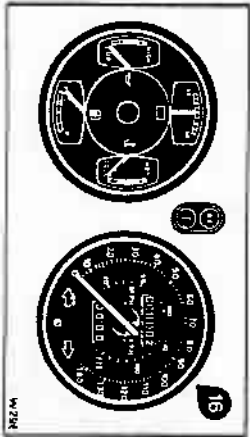
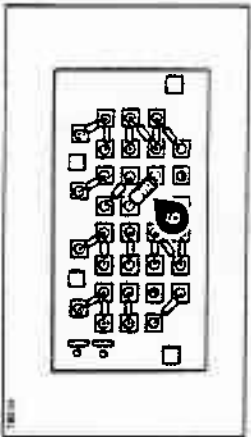
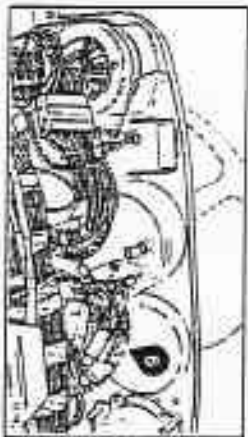
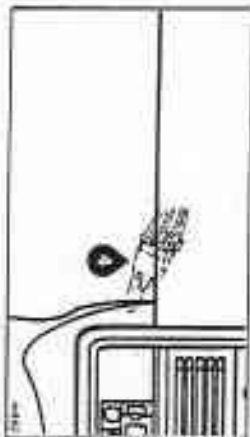
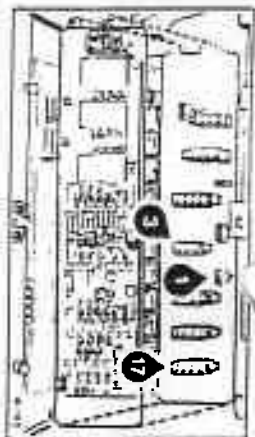
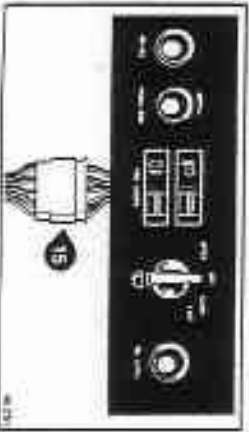
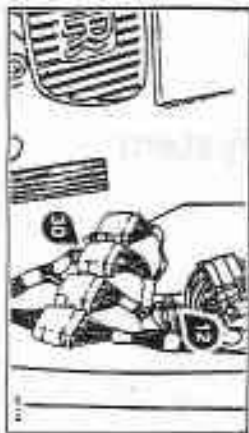
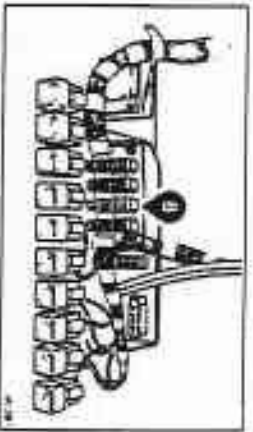
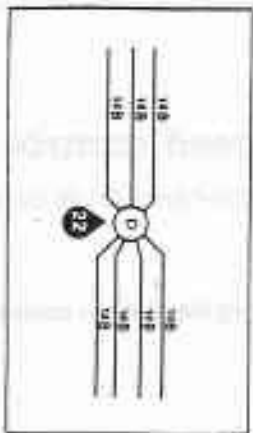
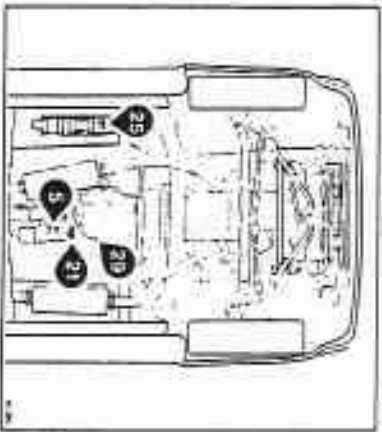
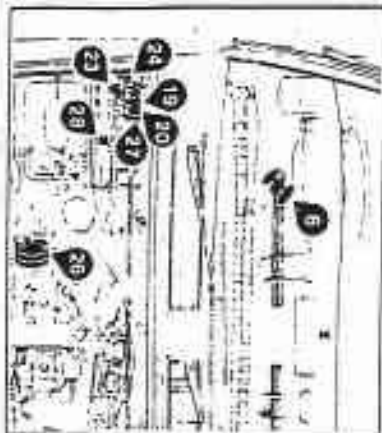
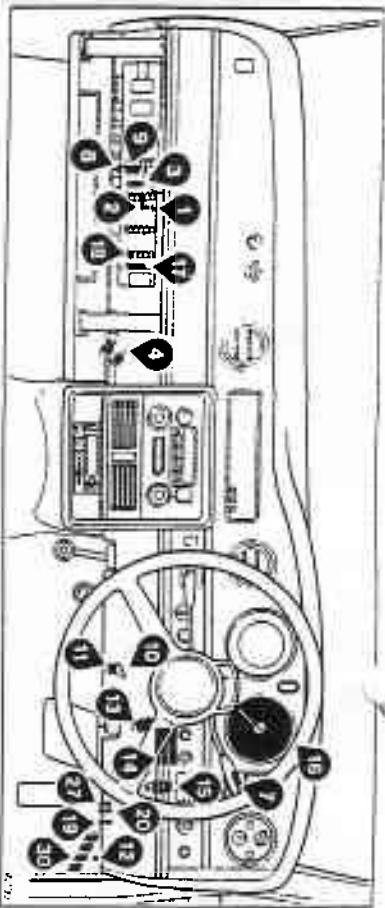

Speed control system

Right-hand drive cars

Wiring diagram and component location

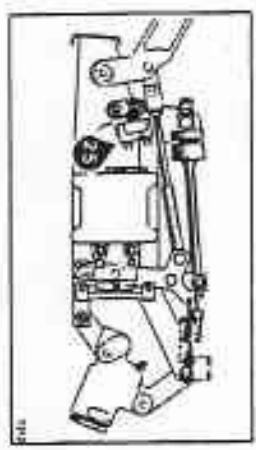
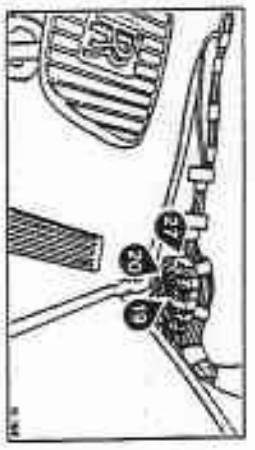
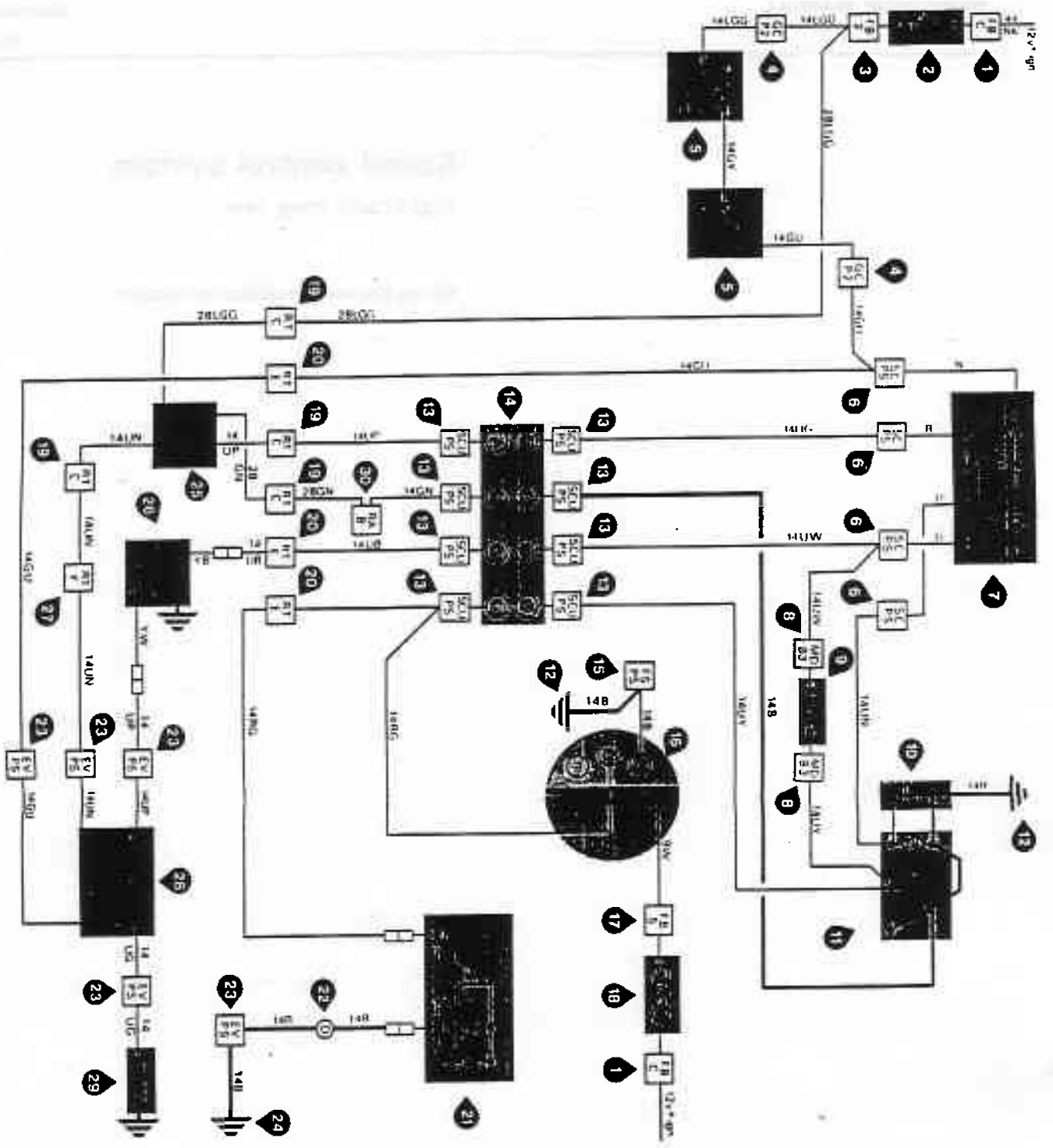

Speed control system

Left-hand drive cars

Wiring diagram and component location

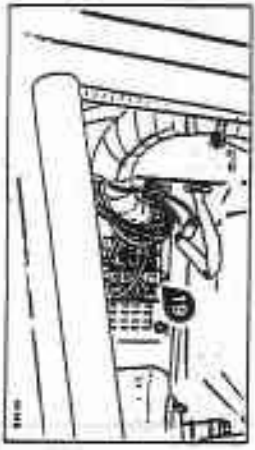
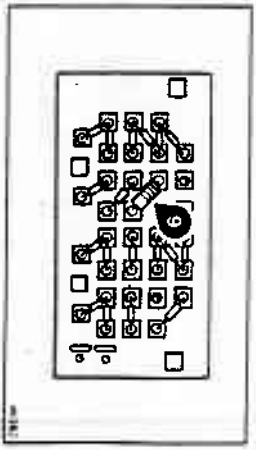
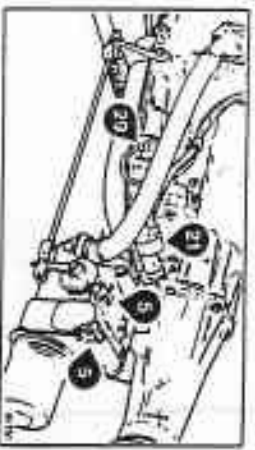
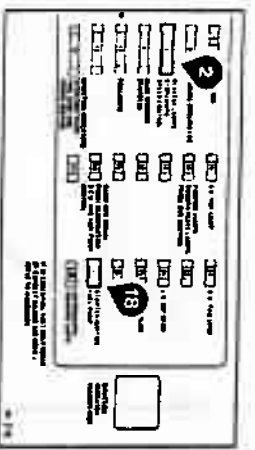
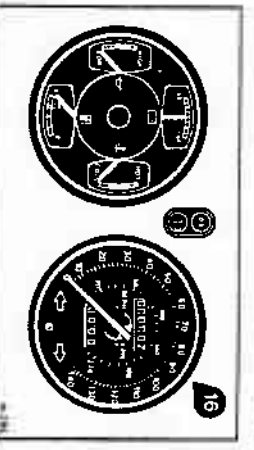
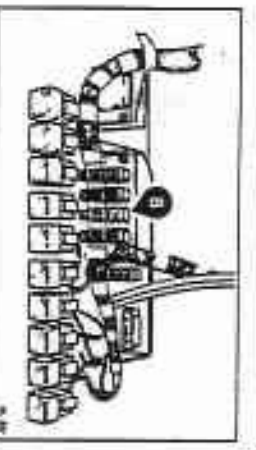
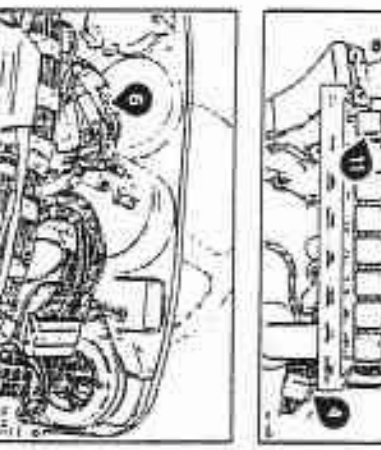
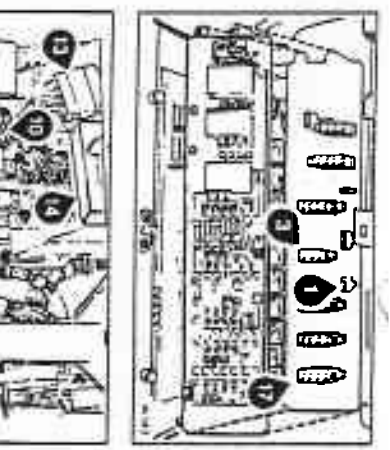
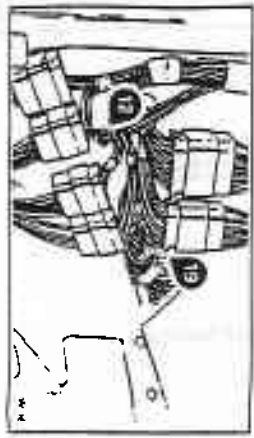
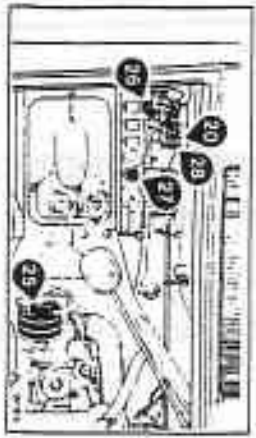
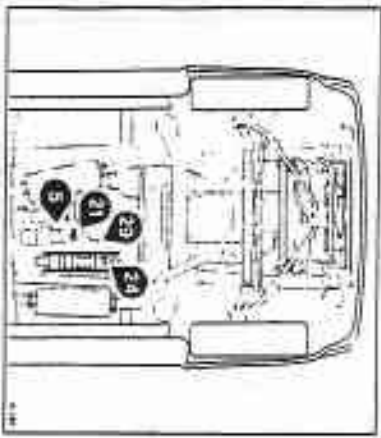
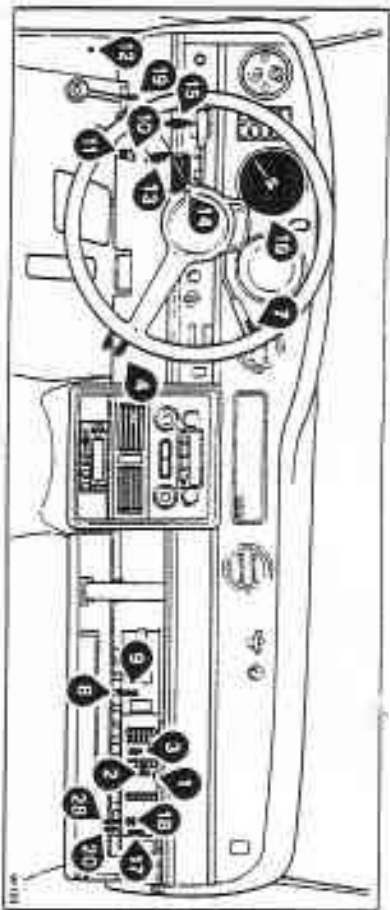

Speed control system

Left-hand drive cars

Wiring diagram and component location

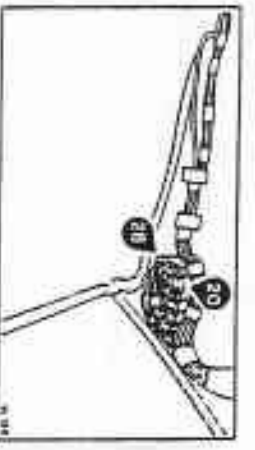
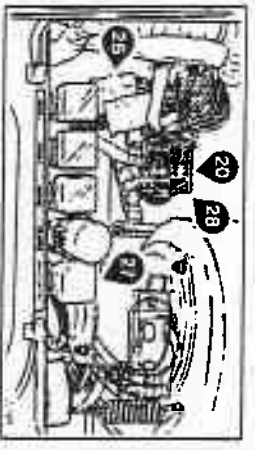
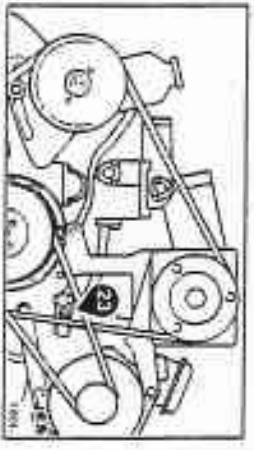
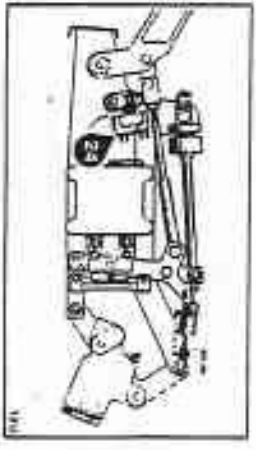
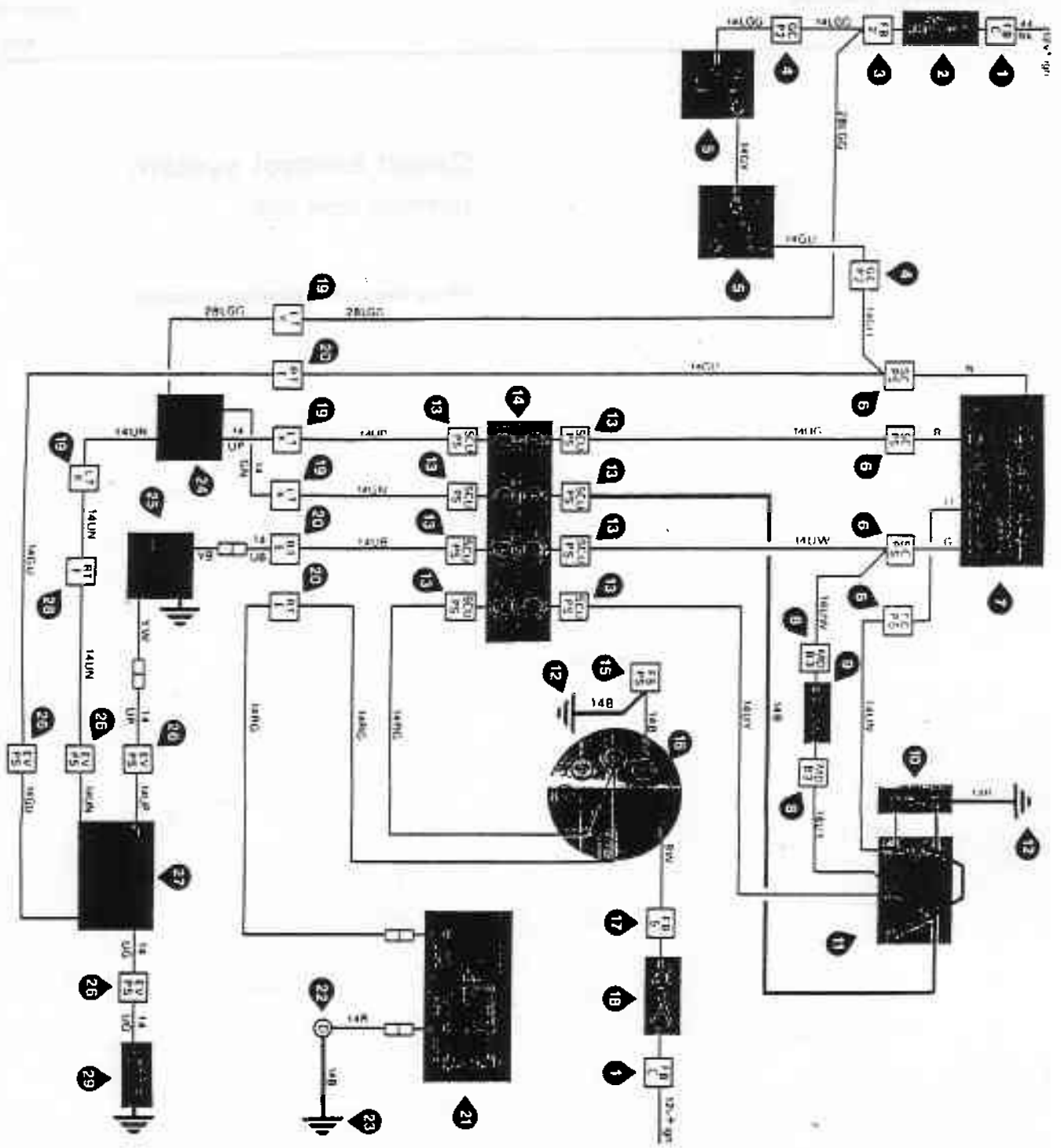

Speed control system

Introduction

It is the purpose of the automatic speed control system to maintain, within close limits, a set cruising speed selected by the driver.

The system will operate only when the car is in top gear. Any cruising speed from 50 km/h (30 mile/h) to 140 km/h (85 mile/h) may be selected to give satisfactory operation of the system. It is not intended that the speed control system be used below 50 km/h (30 mile/h) and at approximately 40 km/h (25 mile/h) the system is disengaged although a memory function operates as described later. The system becomes completely disengaged when either the ignition is switched off, the system is switched off, or the gear range selector lever is moved to Park, Neutral or Reverse.

The controls for the system are mounted on the gear range selector lever (see fig. M8-1). They comprise a three position switch marked ON/OFF and RES (resume) and a push button switch marked SET.

Operation of the system

To use the system the car must be travelling in excess of 50 km/h (30 mile/h) with the gear range selector lever in the Drive range position.

To operate the system move the speed control switch to the ON position, accelerate the car to the desired cruising speed, then, engage the system by briefly depressing the push button switch marked SET. The accelerator pedal can then be released and the car will maintain the selected cruising speed under all road conditions within the limits of the engine performance.

Adjustment of the selected cruising speed can be accomplished as follows.

To cruise at a higher speed than the one already selected, depress the button marked SET. Whilst the button is depressed the speed of the car will increase. When the desired cruising speed is attained, release the SET button. The car may slightly exceed the selected speed when the button is released but will then settle down to the set cruising speed.

Alternatively, a higher set cruising speed can be attained by depressing the accelerator pedal until the required speed is reached, then briefly depressing the SET button.

The system can be disengaged by depressing the footbrake pedal or by moving the speed control switch briefly to the RES position. To resume cruising at the previously set speed, again move the speed control switch briefly to the RES position. Should the speed of the car have fallen below 40 km/h (25 mile/h) during the period of disengagement it will be necessary to accelerate the car to a speed in excess of 40 km/h

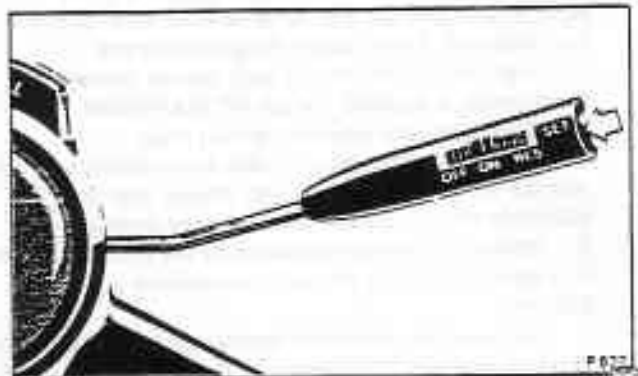

Fig. M8-1 Speed control switches

(25 mile/h) before moving the control switch to the RES position. Moving the switch to the RES position causes the car to return to its previously set cruising speed. This is because a memory of the last set speed is retained within the control unit, despite temporary disengagement by operation of the footbrake pedal or resume switch. This memory function is automatically cancelled when the gear selector lever is moved out of a forward drive position or either the speed control system or ignition system is switched off.

To reduce the set cruising speed, disengage the system by means of the footbrake or by briefly moving the control switch to the RES position. Then, when the desired cruising speed is reached, briefly depress the SET button.

The speed control system may be overridden by the accelerator pedal, for example when overtaking, but will automatically return to the originally selected speed once the pedal is released.

The speed control system only operates on the engine throttle, therefore on downhill gradients in overrun conditions, the selected speed could be exceeded as there would be no automatic selection of a lower gear ratio to give engine braking.

Another feature of the system is that if the gear range selector lever is moved from Drive range to either Intermediate or Low range or an automatic down-change occurs, the speed control system automatically disengages. Depending upon operating conditions, when the selector lever is returned to the Drive range position, or when the car automatically changes back into top gear, the memory within the control unit will return the car to its previously set cruising speed. Should the system not respond automatically briefly select RES on the speed control switch to activate the memory.

Road test procedure

The following road test procedure is recommended to enable both a safety and functional check of the speed control system to be carried out. When carrying out the test procedure select an open stretch of road and ensure that the road is free from any potential hazard.

Safety inhibit systems

1. Ensure that the speed control switch is in the OFF position and that the gear range selector lever is in the Park position. Firmly apply the parking brake.
2. Start and run the engine until normal operating temperature is attained. Switch off the ignition.
3. Disconnect the actuator bellows chain.
4. Ensure that the vacuum hoses are in good condition and the connections secure. Also ensure that the operation of the actuator bellows is not obstructed.
5. When checking the operation of the actuator bellows it is essential that the following procedures are observed.

Although the footbrake should not be applied during Operations 6 and 7, it is essential that no persons stand in front of the car and that the driver be prepared to apply the footbrake immediately, should any forward movement of the car occur.

6. Ensure that the parking brake is firmly applied. Raise the bonnet of the car. Start the engine and move the gear range selector lever to the Drive range position.

Ensure that no compression of the bellows occurs.

7. Move the speed control switch to the ON position and again check that no compression of the bellows occurs.
8. Move the gear range selector lever to the Park position, the speed control switch to the OFF position and then switch off the ignition.
9. Open and close the throttle to ensure that the operation of the throttle linkage is not obstructed. Then connect the actuator bellows to throttle linkage chain (see fig. MB-2). Adjust the chain by pulling it taut across the gap between the throttle linkage connection and bellows actuator connection and then release it by one ball.
10. Firmly apply the footbrake. Start the engine and move the gear range selector lever to the Drive range position. Move the speed control switch to the ON

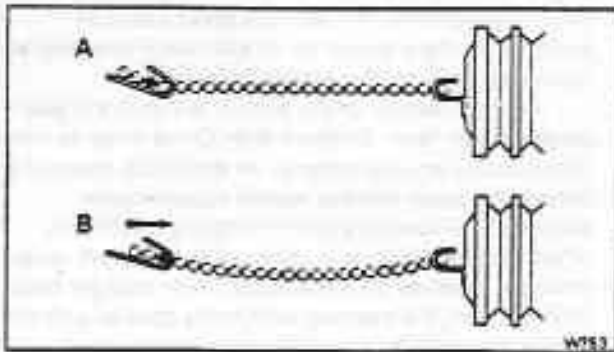

Fig. MB-2 Actuator bellows chain adjustment
 A Chain pulled taut
 B Chain correctly set

position, then slowly release the footbrake.

Ensure that the engine revs do not increase.

11. Release the parking brake and accelerate to approximately 70 km/h (45 mile/h). Briefly depress the SET button.

Ensure that the speed control system engages and that the speed is maintained at approximately 70 km/h (45 mile/h).

12. Move the gear range selector lever to the Intermediate position.

Ensure that the system disengages.

13. Allow the speed of the car to decrease (without applying the footbrake) to approximately 60 km/h (35 mile/h) and then move the gear range selector lever back to the Drive range position.

14. The memory within the control unit should automatically function to return the speed of the car to approximately 70 km/h (45 mile/h). Should the system not respond automatically select RES on the speed control switch to activate the memory function of the unit.

15. Apply the footbrake.

Ensure that the system disengages.

16. Switch off the speed control system.

Functional test

1. With the car travelling at a steady speed of 50 km/h (30 mile/h) move the speed control switch to the ON position. Briefly depress the SET button.

Ensure that the car cruises at a constant speed of 50 km/h \pm 3 km/h (30 mile/h \pm 2 mile/h).

2. Accelerate the car to 80 km/h (50 mile/h) and holding the speed steady for three to four seconds, briefly depress the SET button.

Ensure that the car cruises at 80 km/h \pm 3 km/h (50 mile/h \pm 2 mile/h).

3. Increase the speed of the car by depressing the SET button. Release the button when the car speed has reached 100 Km/h (60 mile/h).

Ensure that the car cruises at 100 km/h \pm 3 km/h (60 mile/h \pm 2 mile/h).

The car may slightly exceed the selected speed when the button is released but should then settle down to the set cruising speed.

4. Apply the footbrake to reduce the speed of the car to approximately 80 km/h (50 mile/h) and then briefly move the speed control switch to the RES position.

Ensure that the car accelerates to and cruises at 100 km/h \pm 3 km/h (60 mile/h \pm 2 mile/h).

5. Briefly move the speed control switch to the RES position.

Ensure that the speed control system is disengaged and the car decelerates.

6. Briefly move the speed control switch to the RES position.

Ensure that the car accelerates to and cruises at 100 km/h \pm 3 km/h (60 mile/h \pm 2 mile/h).

7. Move the speed control switch to the OFF position. Reduce the speed of the car to approximately 80 km/h (50 mile/h) and then briefly press the SET button.

Ensure that the system does not engage.

8. Move the speed control switch to the ON position

and then briefly to the RES position.

Ensure that the system does not engage.

9. With the speed of the car at 65 km/h (40 mile/h) briefly press the SET button to engage the system. Then apply the footbrake to reduce the speed of the car to 25 km/h (15 mile/h). Briefly operate the RES switch and then the SET button.

Ensure that the system does not engage.

10. Stop the car. Move the gear range selector lever to the Neutral position and then back to the Drive range position. Accelerate to 60 km/h (35 mile/h) then briefly operate the RES switch.

Ensure that the system does not engage.

11. Accelerate the car to 80 km/h (50 mile/h) and then briefly press the SET button to engage the system. Apply the footbrake to reduce the speed of the car to 65 km/h (40 mile/h), then briefly operate the RES switch.

Ensure that the car accelerates to 80 km/h (50 mile/h) within ten seconds.

12. Move the speed control switch to the OFF position.

Electrical test and fault diagnosis

The following test procedure describes the use of the speed control electronic test box, part number RH 9689. Also provided is a fault diagnosis procedure.

If having carried out an operation in the test procedure the required result is not obtained, reference must be made to the same operation number in the fault diagnosis procedure. This will give the correction procedure which must be carried out before the test procedure can be continued.

Successful completion of the test in conjunction with the fault diagnosis procedure should prove the correct electrical operation of the system.

Note

The electrical test and fault diagnosis procedures do not cover; the mechanical operation of the bellows actuator, the operation of the TCS (top gear) switch, the speedometer generator system, or the memory erase at switch-on of the electronic unit. The operation of these functions is dealt with in the Functional test procedure on Page M8-10.

It is essential that the electrical system of the car being tested is capable of providing 12.5 volts throughout the test procedure. To achieve this the car battery must be in a fully charged condition and connected to a low current type battery charger. Do not disconnect the battery from the car.

Connecting the test box (see fig. M8-3)

1. Ensure that the parking brake is firmly applied.
2. Remove the interior lamps fuse number 1 from the fuseboard.
3. Remove the white/green cable from the positive connection on the ignition coil.
4. Remove the speed control safety relay (see Section M2 figure M2-1, item 25) and replace with the test relay part number RH 9705.
5. Disconnect the speed control wiring loom from the electronic speed control unit and connect the test box.
6. On the test box, select the SZ position on the SY/SZ

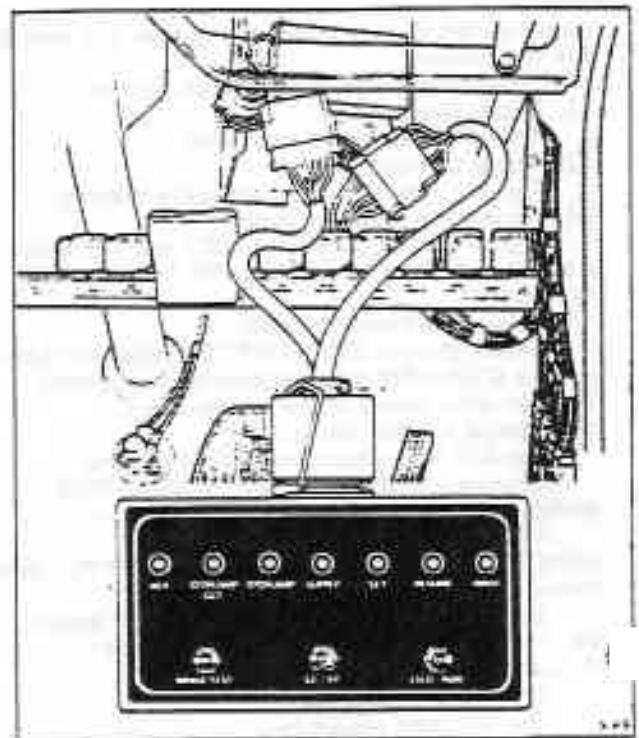

Fig. M8-3 Connecting the test box

switch; also the RUN position on the LSL/O (low speed lock out)/RUN switch.

Test procedure

1. Switch on the ignition.
 - Ensure that none of the lamps on the speed control test box illuminate.
2. Move the gear range selector lever from Park through Neutral to the Drive position.
 - Ensure that none of the lamps on the test box illuminate.
3. Move the speed control switch to the ON position.
 - Ensure that on the test box, the SUPPLY and STOPLAMP CCT (circuit) lamps illuminate, the INPUT lamp either illuminates or flashes, and the speedometer registers approximately 80 km/h (50 mile/h).
4. Press and hold the SET button on the speed control switch.
 - Ensure that the SET lamp on the test box illuminates and that the RESUME lamp does not illuminate.
5. Release the SET button.
 - The ACT lamp should commence flashing.
6. Press and hold the SET button.
 - The ACT lamp should be extinguished.
7. Release the SET button.
 - The ACT lamp should recommence flashing.
8. Select and hold the RES position on the speed control switch.
 - Ensure that the RESUME lamp on the test box illuminates and the ACT lamp is extinguished.
9. Release the RES switch.
 - Ensure that the RESUME lamp is extinguished.
10. Select and hold the RES position on the speed

control switch for a minimum of a quarter of a second and then release.

The ACT lamp should commence flashing.

11. Repeat Operation 10.

The ACT lamp should extinguish.

12. Repeat Operation 10.

The ACT lamp should recommence flashing.

13. Depress the footbrake pedal.

Ensure that the STOPLAMP CCT and ACT lamps are extinguished and the STOPLAMP indicator lamp illuminates.

14. Release the footbrake pedal.

Ensure that the STOPLAMP CCT lamp illuminates and the STOPLAMP indicator lamp is extinguished. The ACT lamp should remain extinguished.

15. Operate the RES switch.

The ACT lamp should commence flashing.

Select the LSLO position on the LSLO/RUN switch.

The speedometer reading should fall to approximately 30 km/h (20 mile/h) and the ACT lamp should extinguish.

Select RUN position on the LSLO/RUN switch.

16. Press and hold the BRAKE TEST switch throughout this operation.

Operate the RES switch.

The ACT lamp should flash.

Depress the footbrake pedal.

The ACT lamp should extinguish.

Release the footbrake pedal.

The ACT lamp should recommence flashing.

17. Turbocharged cars only

Check the operation of the vacuum pump as follows

With the ignition switched on, the gear range selector lever in Drive range position, and the speed control switch set to ON, ensure that the vacuum pump is running. Disconnect the vacuum hose from the pump to the actuator vacuum line and ensure that the pump is withdrawing air. Set the speed control switch to OFF and ensure that the pump stops. Set the speed control switch to ON, remove the test relay and replace the speed control safety relay. Ensure that the pump does not run. Reconnect the vacuum pipes.

18. Switch off the ignition. Disconnect the test box and reconnect the speed control electronic unit plug and socket. Remove the test relay and replace the speed control safety relay. Replace the interior lamps fuse number 1 in the fuseboard. Reconnect the white/green cable to the positive connection on the ignition coil.

19. Road test the speed control system.

Note

Should the rectification time for the speed control system electrical test procedure become protracted, it is recommended that fuse number 27 be removed from the fuseboard. This prevents an inordinately high mileage being recorded on the odometer.

Fault diagnosis procedure

1. If any lamp on the test box illuminates there are faults in both the gearbox actuator micro-switch and the speed control switch. Alternatively, the blue/green supply cable from the speed control switch to the electronic control unit is picking up a supply from another source.

2. If any lamp illuminates, the ON/OFF contacts of the speed control switch are short-circuited; therefore

replace the switch.

3. If no lamp on the test box illuminates and the speedometer is inoperative, first check fuse number 10 speedometer is inoperative, first check the light green/green, green/yellow, and green/blue cables, also the reversing lamps switch.

If the STOPLAMP CCT lamp is not illuminated, ensure that the stop lamps bulbs and stop lamps failure unit are correct. Then, check the continuity of the green/brown cable connecting the speed control to the stop lamps circuit.

If the INPUT lamp does not illuminate and the speedometer is inoperative, ensure that fuse 27 is intact. Then, check the continuity of the red/green cable between the speedometer and the speed control circuit.

4. Should no lamp on the test box illuminate and the relay clicks, check the speed control to relay wiring (blue/white cable, 470Ω resistor, and blue/yellow cable) and then the relay.

If the relay does not click check the continuity of the blue/brown cable from the speed control switch to the relay. Then, check the speed control switch and relay.

5. If the ACT lamp does not flash ensure that the supply voltage is at least 12.5 volts and that the test relay is fitted; check the continuity of the blue/brown cable from the control unit to the actuator (via the stop lamps switch and safety relay).

If these checks prove correct substitute the electronic control box with a proven unit.

6. If the ACT lamp continues flashing the electronic control unit is faulty.

Replace with a proven unit.

7. If the ACT lamp remains off the speed control switch is faulty and must be renewed.

8. If the RESUME lamp does not illuminate and the relay clicks, check the blue/yellow cable from the electronic control unit to the relay.

If the relay does not click the speed control switch is faulty and must be renewed.

If the RESUME lamp illuminates but the ACT lamp continues to flash, the electronic control unit is faulty and must be renewed.

9. If the ACT lamp commences flashing when RESUME is released check the fitting and operation of the diode connected across the relay coil.

10. 11. and 12. If the operation of the ACT lamp differs from that given in the test procedure, check that the RESUME lamp is illuminated with every operation of the RES switch then change the electronic control unit.

13. If no response is obtained, ensure that the stop lamps circuit operates correctly.

14. If the ACT lamp recommences flashing check the continuity of the green/brown cable between the electronic control unit and the stop lamps switch.

15. If the ACT lamp is not extinguished the LSLO (low speed lock out) function of the electronic control unit is faulty and the unit must be renewed.

16. If the ACT lamp is not extinguished when the footbrake pedal is depressed, either the stop lamps micro-switch is faulty or a short circuit exists between the blue/brown and blue/purple cables to the switch.

17. Turbocharged cars only

If the vacuum pump does not operate proceed as follows.

Disconnect the light/green and pink/black vacuum pump cables at the right-hand valance connections. Provide a known 12 volt positive feed to the light/green cable supplying the vacuum pump and a known earth to the pink/black cable supplying the vacuum pump. If the pump now operates it will be necessary to check the vacuum pump circuitry (refer to publication TSD 4417 page B1-1). Should the vacuum pump not operate replace the pump.

Ensure that all electrical connections are remade and the vacuum pipes reconnected.

18. Switch off the ignition. Disconnect the test box and reconnect the electronic unit plug and socket. Remove the test relay. Ensure that all connections are remade and any fuses which have been removed, replaced.

19. Road test the car to check the speed control system.

Speed control system

· Left-hand drive cars

Silver Spirit, Silver Spur, Mulsanne
(excluding Turbo), and Bentley Eight

· Wiring diagram

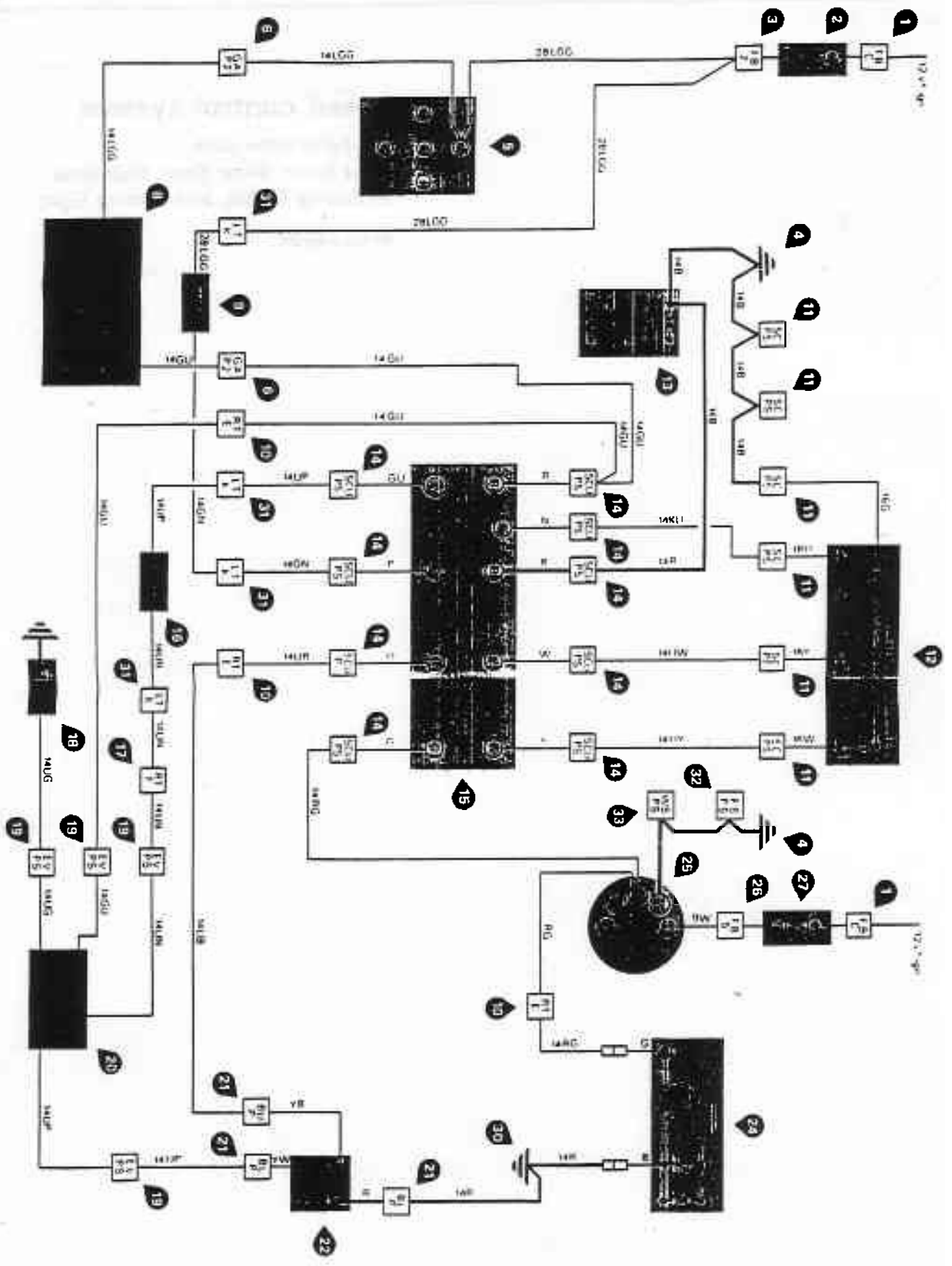

Speed control system

Bentley Mulsanne Turbo and Bentley Turbo R

Component location

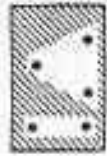

Cars fitted with a CAV alternator

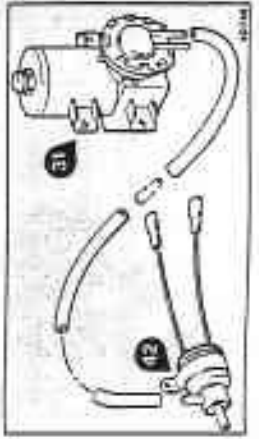
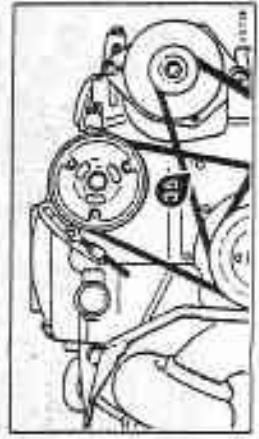
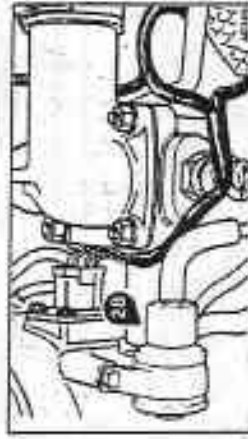
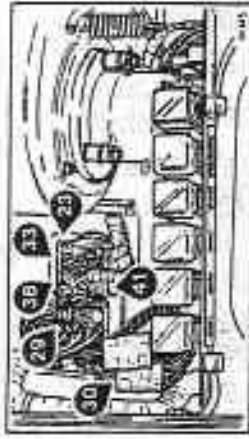
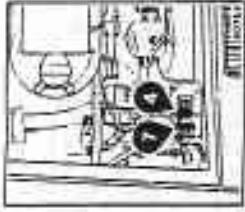

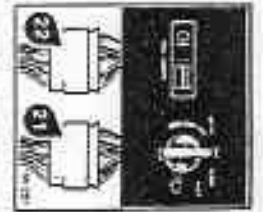
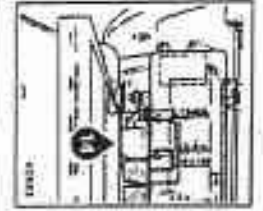
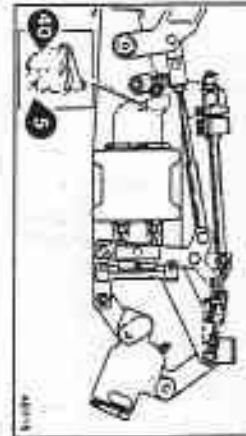
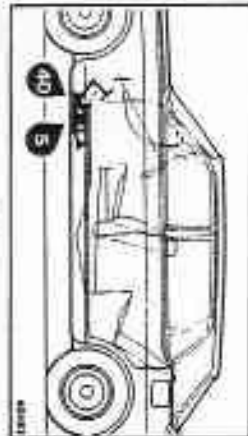
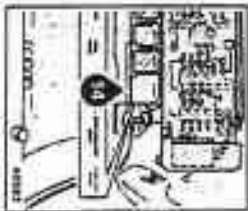
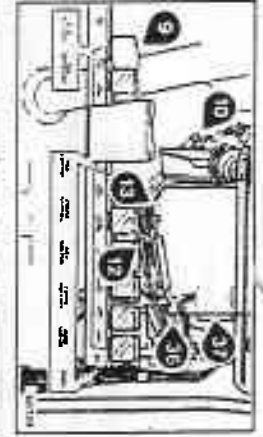
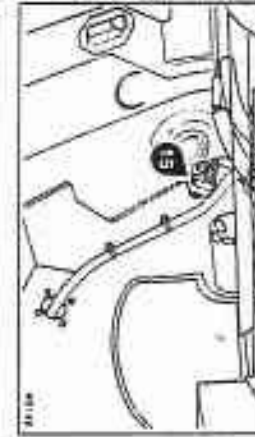
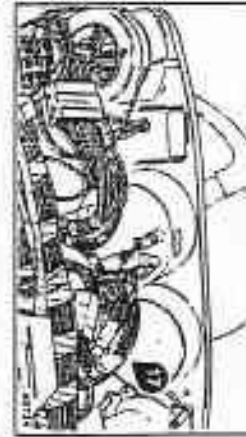
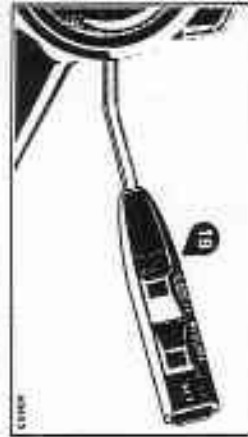
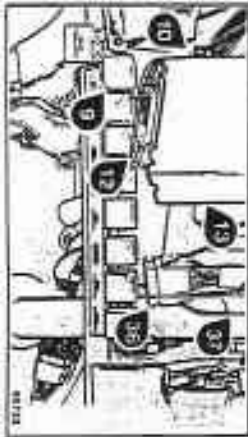
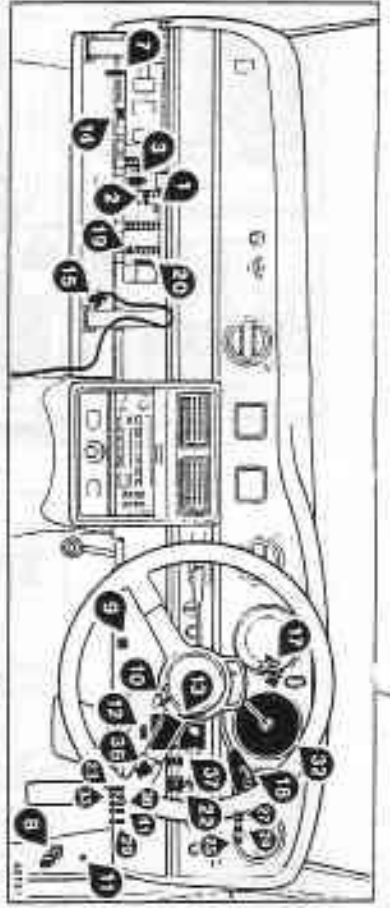
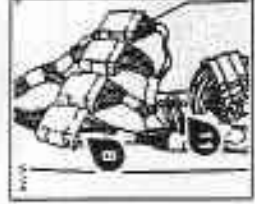
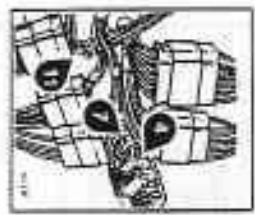
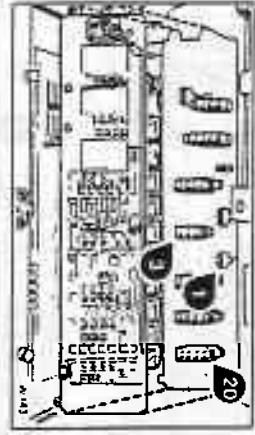
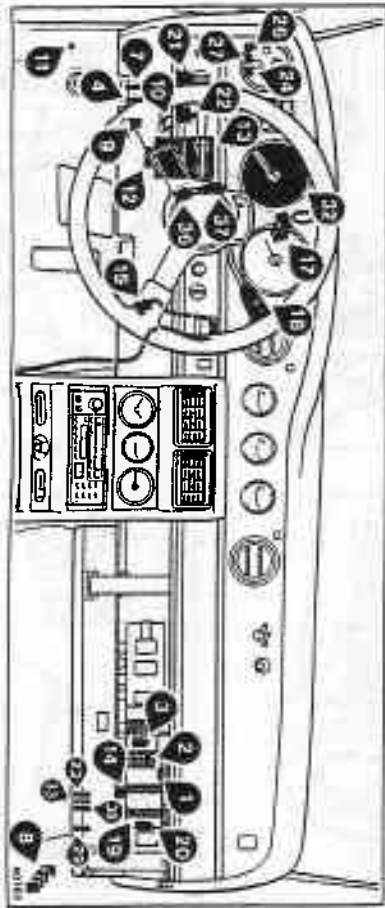

Speed control system

Right-hand drive cars

Bentley Mulsanne Turbo and Bentley Turbo R

Wiring diagram

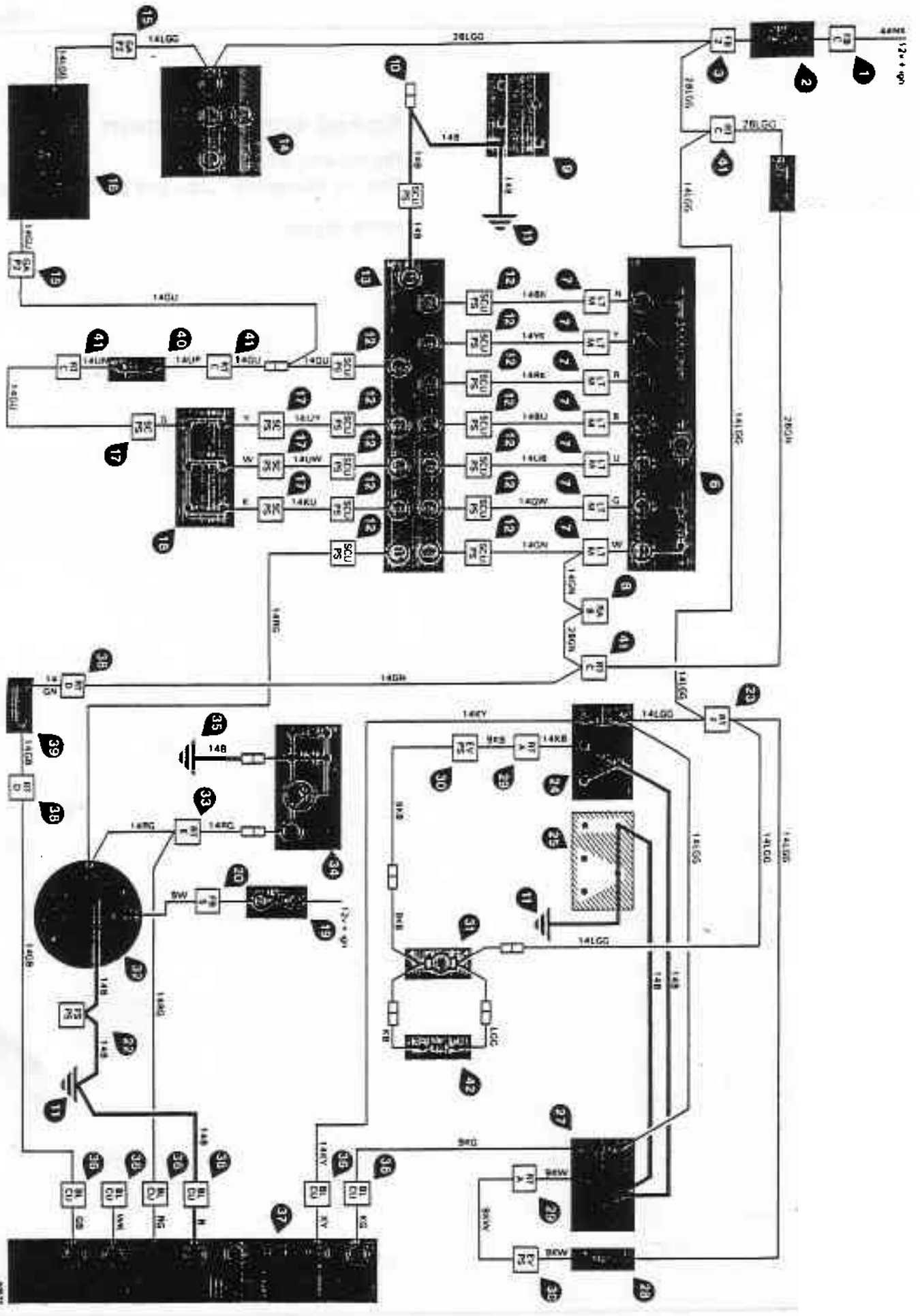

12V DC

230V AC

230V AC

230V AC

230V AC

230V AC

230V AC

230V AC

230V AC

230V AC

230V AC

230V AC

230V AC

230V AC

230V AC

230V AC

230V AC

230V AC

12V DC

230V AC

230V AC

230V AC

230V AC

230V AC

230V AC

230V AC

230V AC

230V AC

230V AC

230V AC

230V AC

230V AC

230V AC

230V AC

230V AC

230V AC

Speed control system

Left-hand drive cars

Bentley Mulsanne Turbo and Bentley Turbo R

Wiring diagram

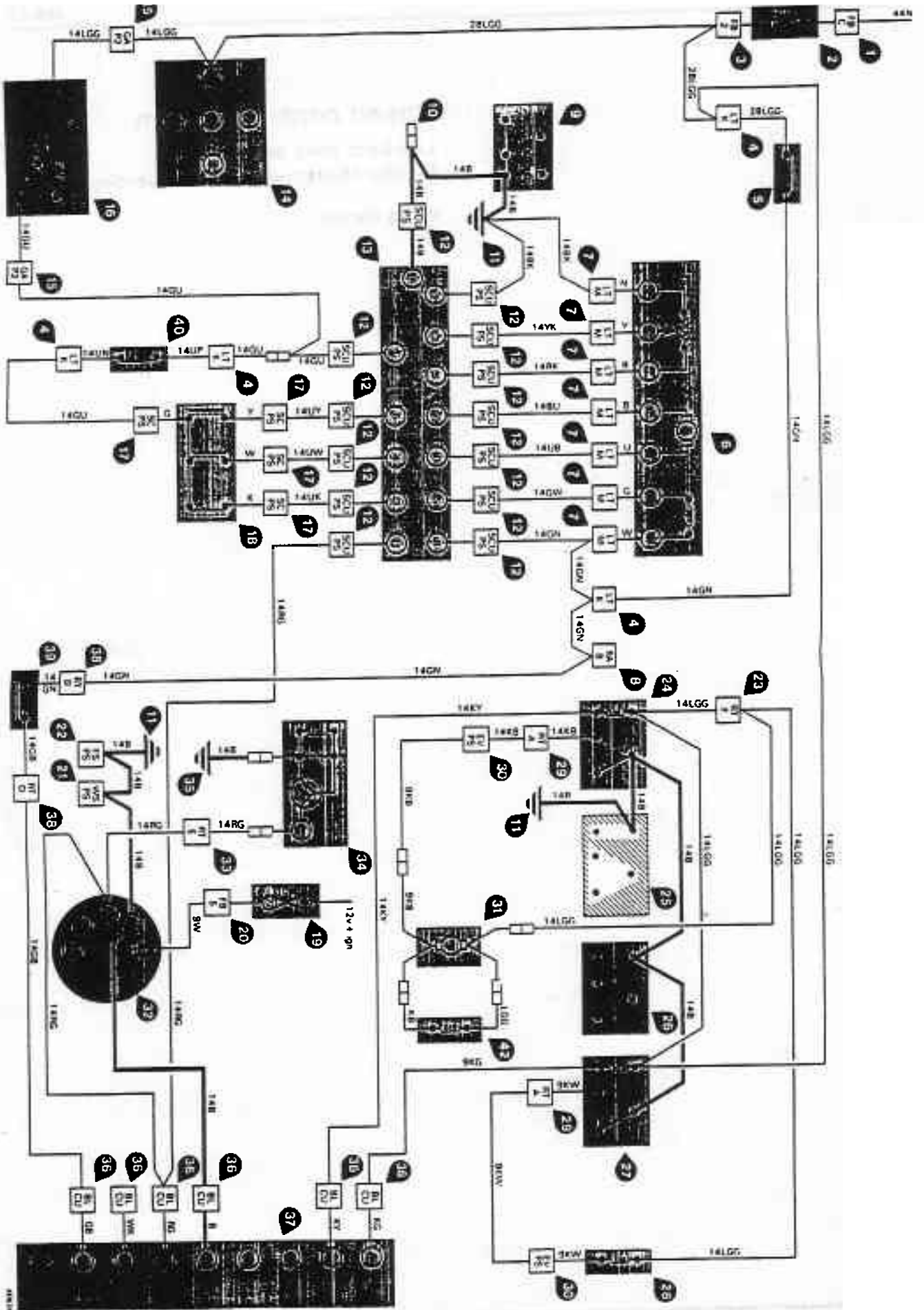

Speed control system
Corniche/Continental

Component location

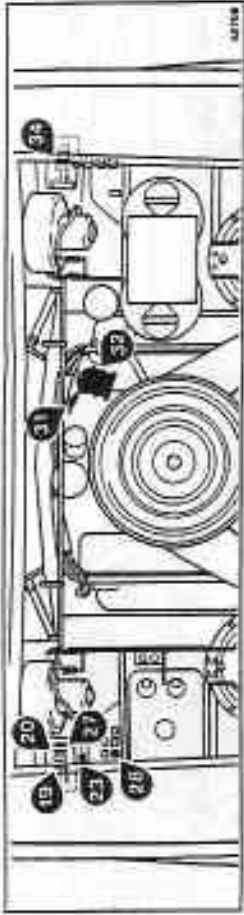

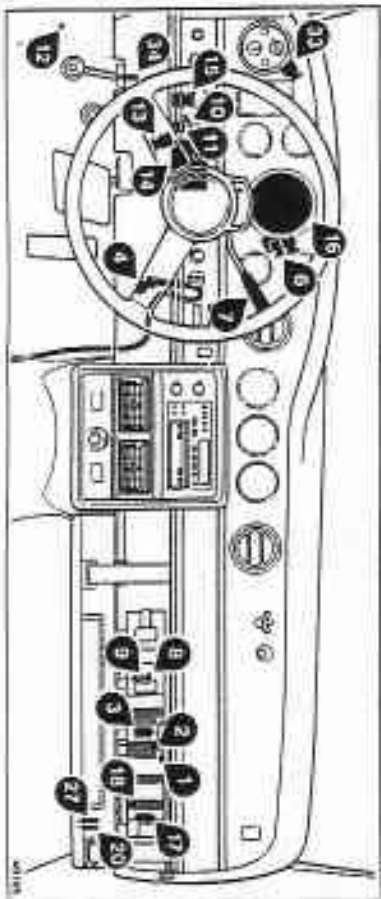

Airbag Light Tire Pressure Monitoring System (TPMS) Light
 ABS Light Brake System Warning Light
 Engine Oil Pressure Warning Light Engine Coolant Temperature Warning Light
 Battery Charge Indicator Light Transmission Oil Pressure Warning Light
 Air Filter Service Indicator Light Air Filter Service Interval Light
 Air Filter Service Interval Light (with odometer) Air Filter Service Interval Light (with trip meter)

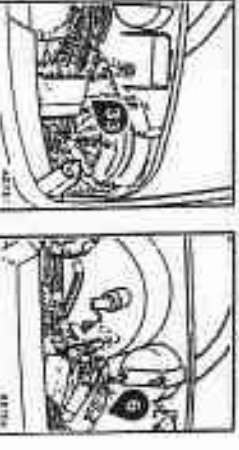
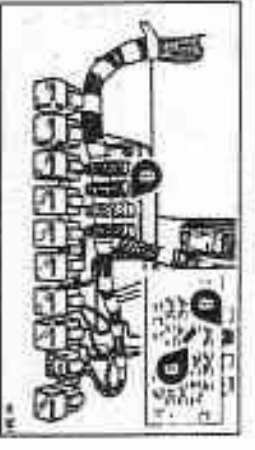
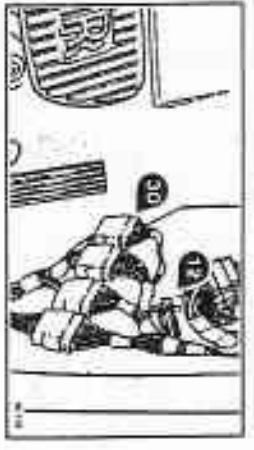
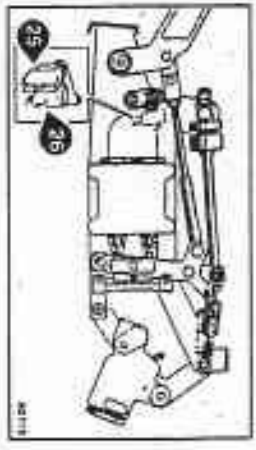
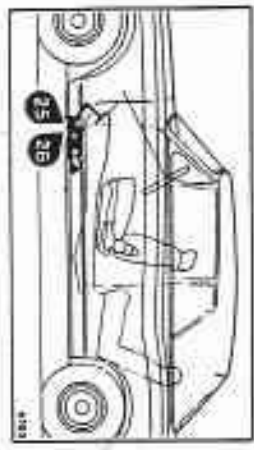
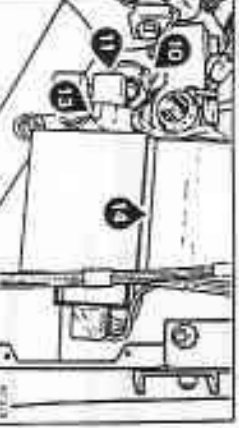
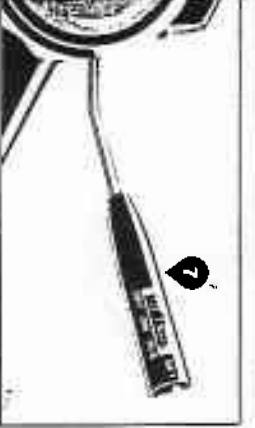
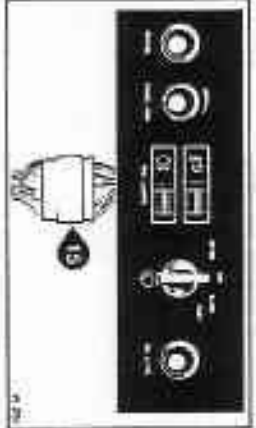
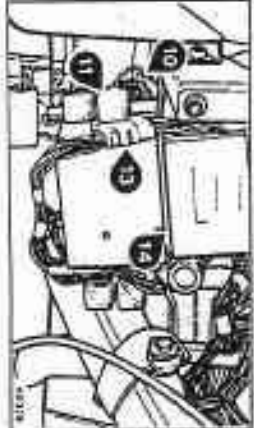
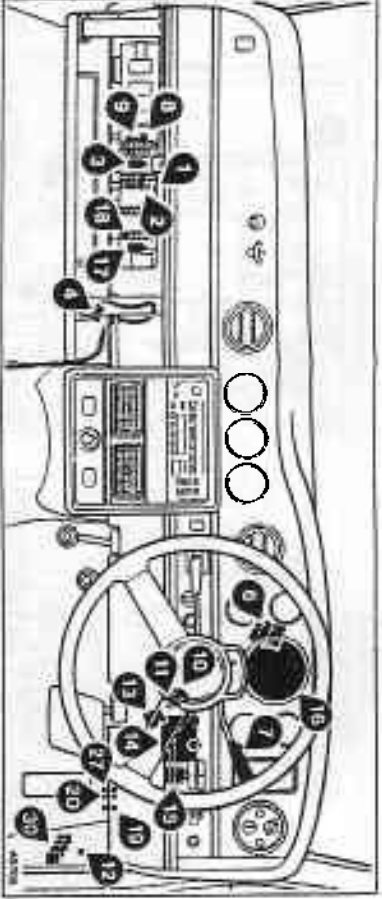
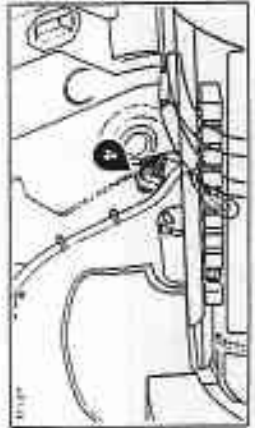
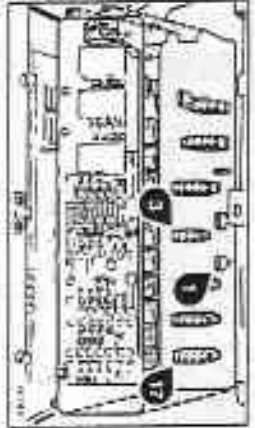

Speed control system

Right-hand drive cars
Corniche/Continental

Wiring diagram

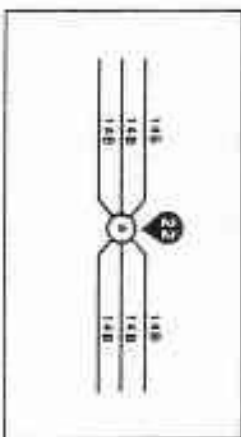
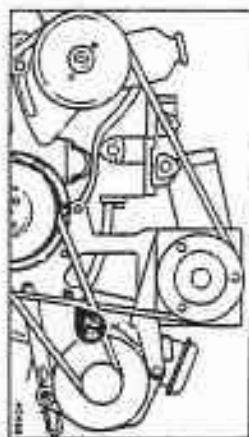
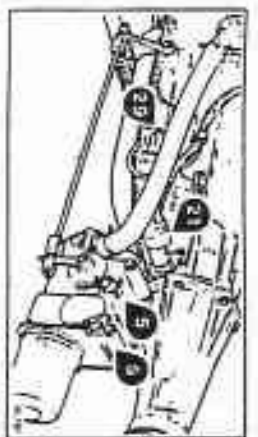
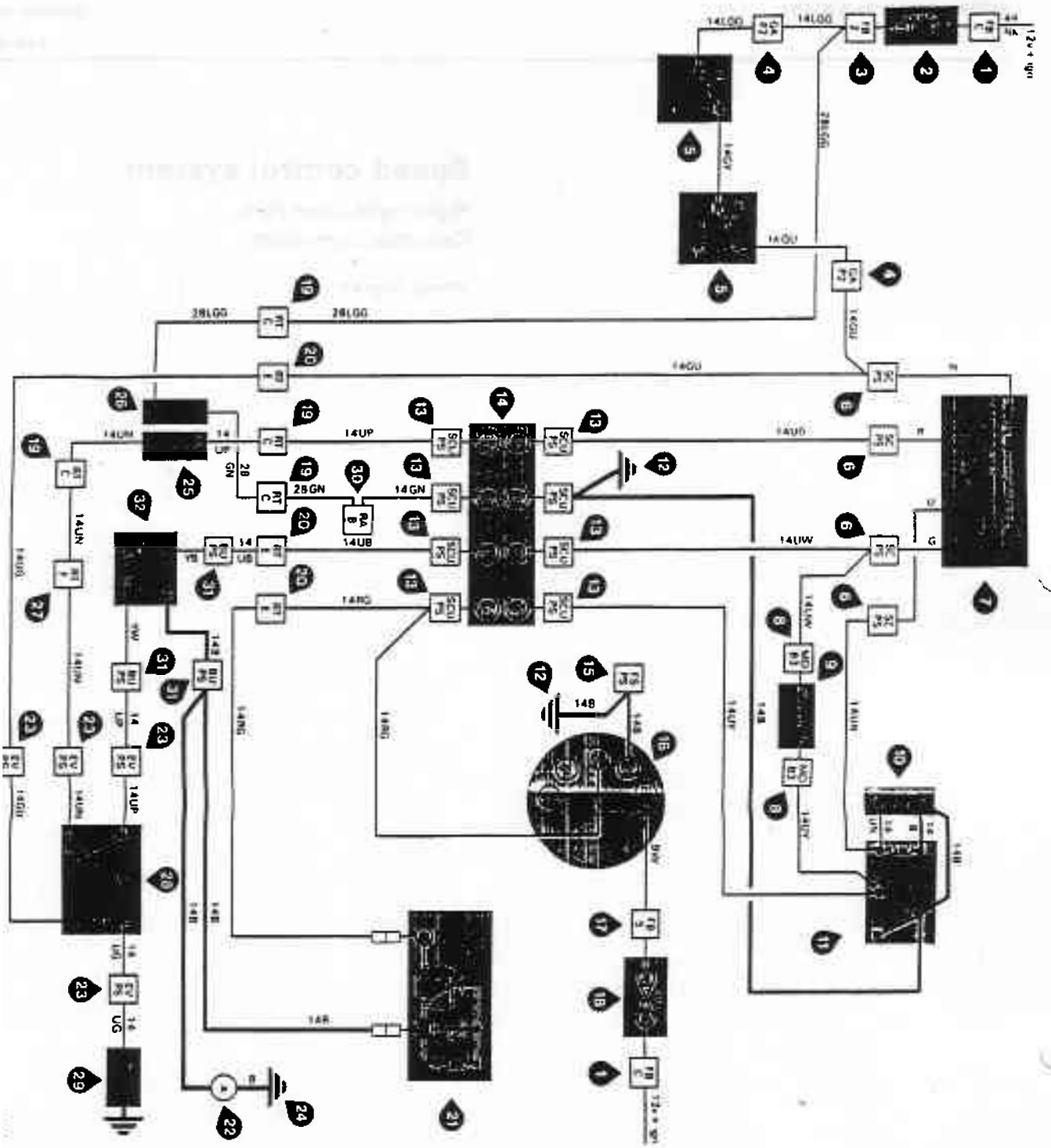

Speed control system

Left-hand drive cars
Corniche/Continental

Wiring diagram

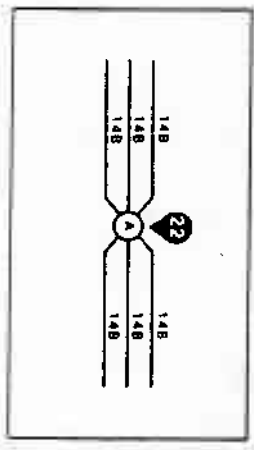
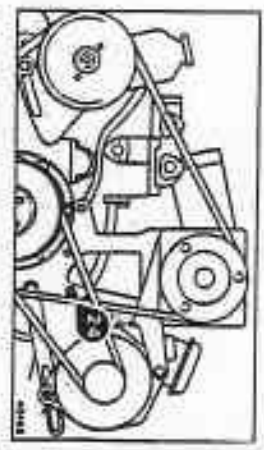
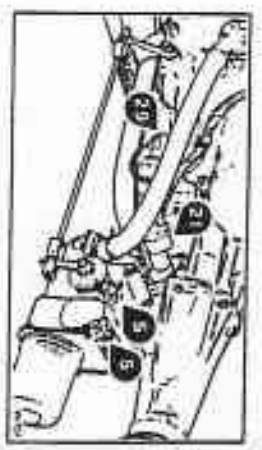
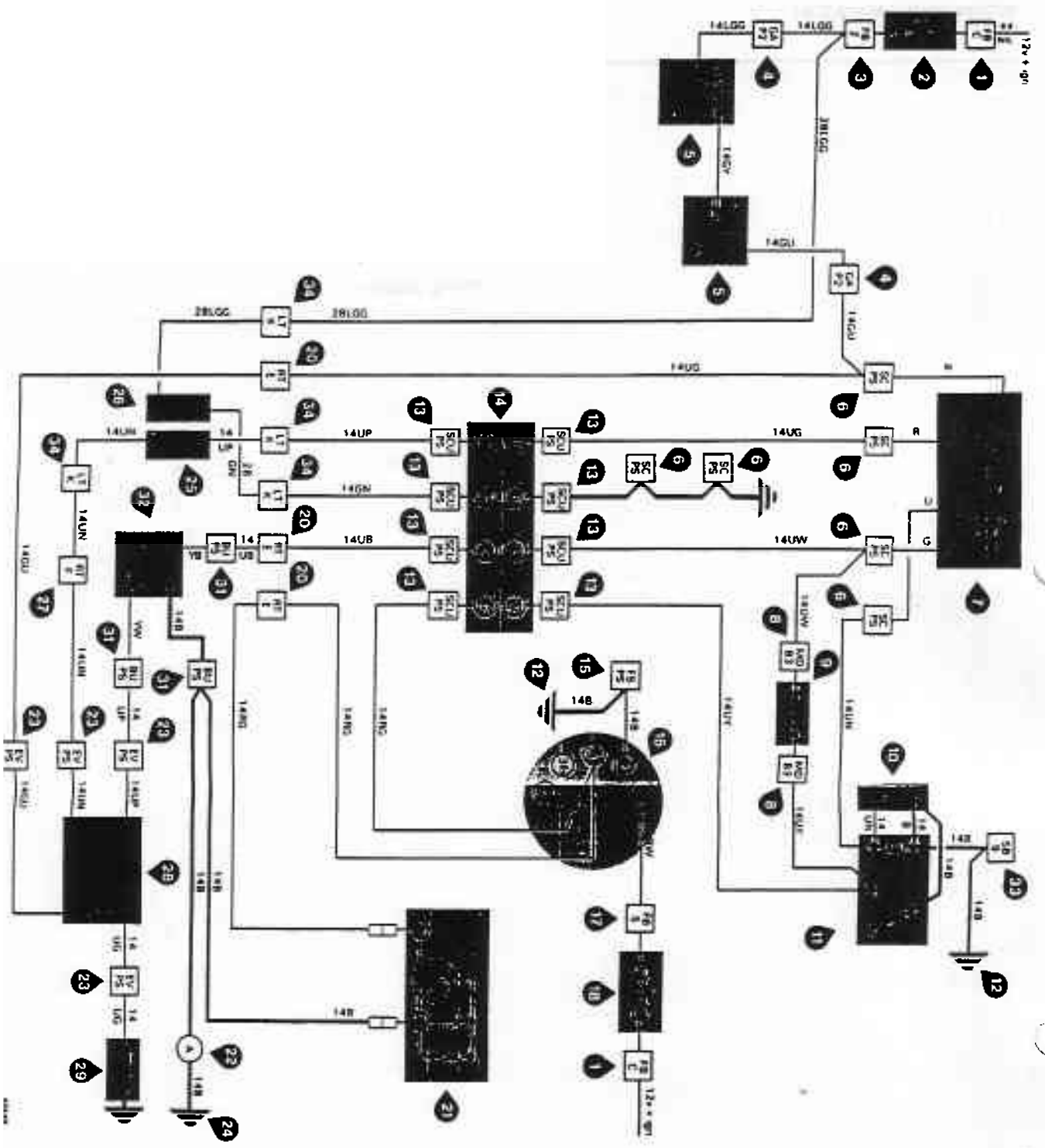

Speed control system Corniche/Continental

Component location

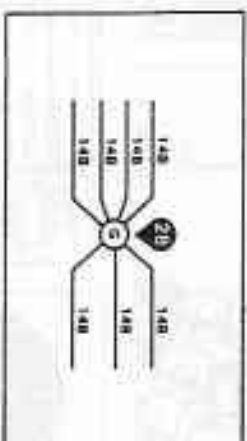
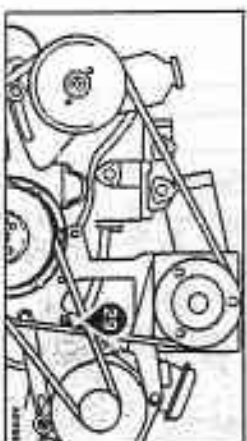
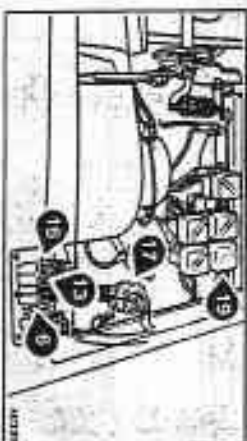
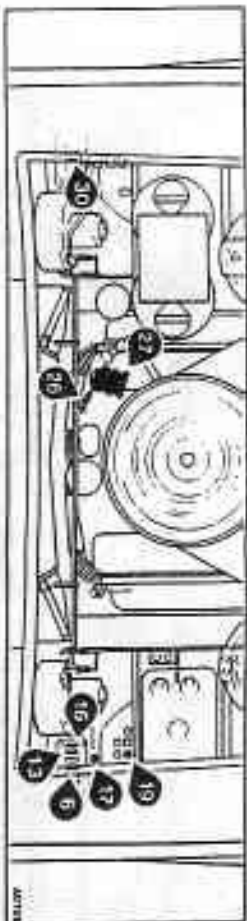

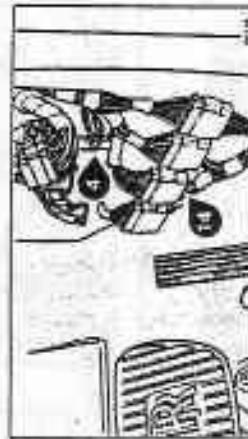
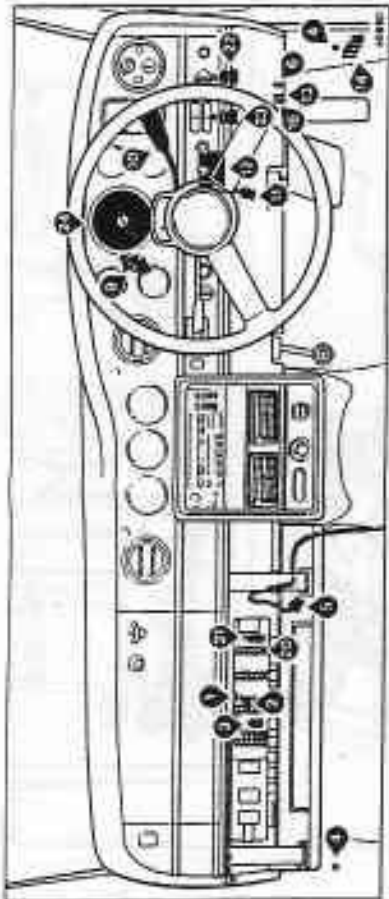
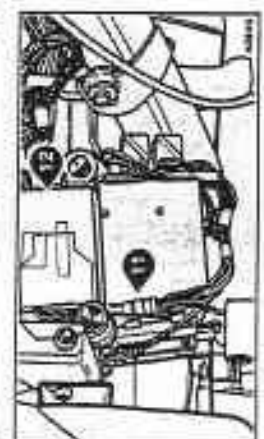
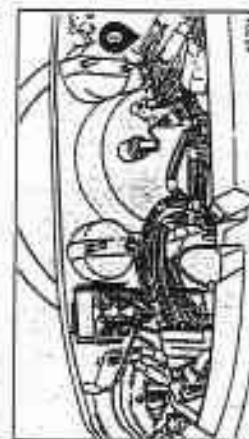
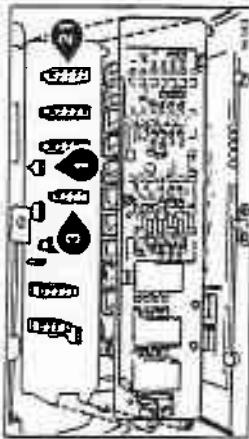
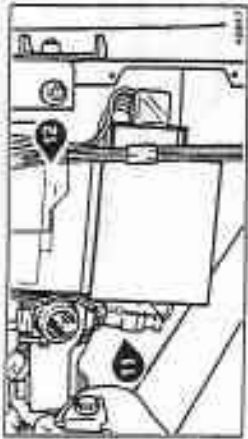
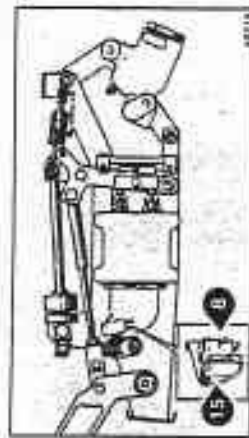
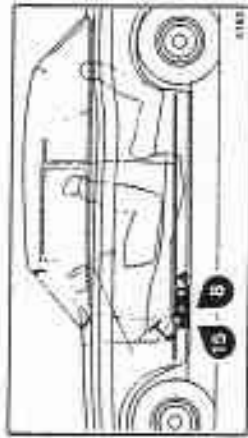
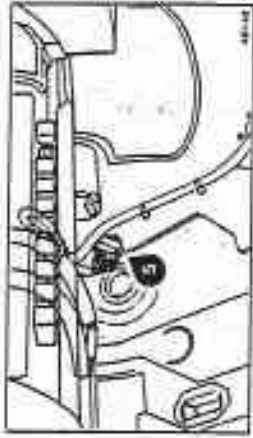
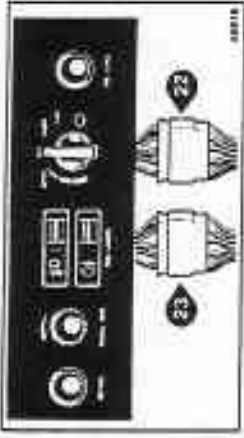

ITEM NO.	DESCRIPTION	QTY	UNIT	REMARKS
1
2
3
4
5
6
7
8
9
10
11
12
13
14
15
16
17
18
19
20
21
22
23

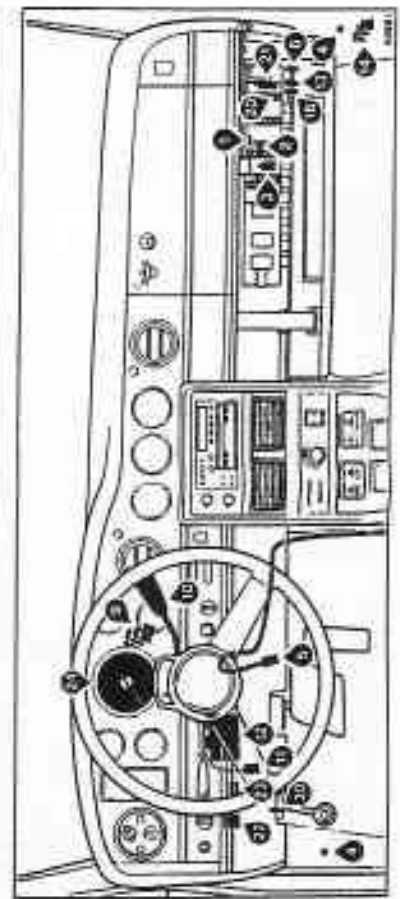

Speed control system

Right-hand drive cars

Corniche/Continental

Wiring diagram

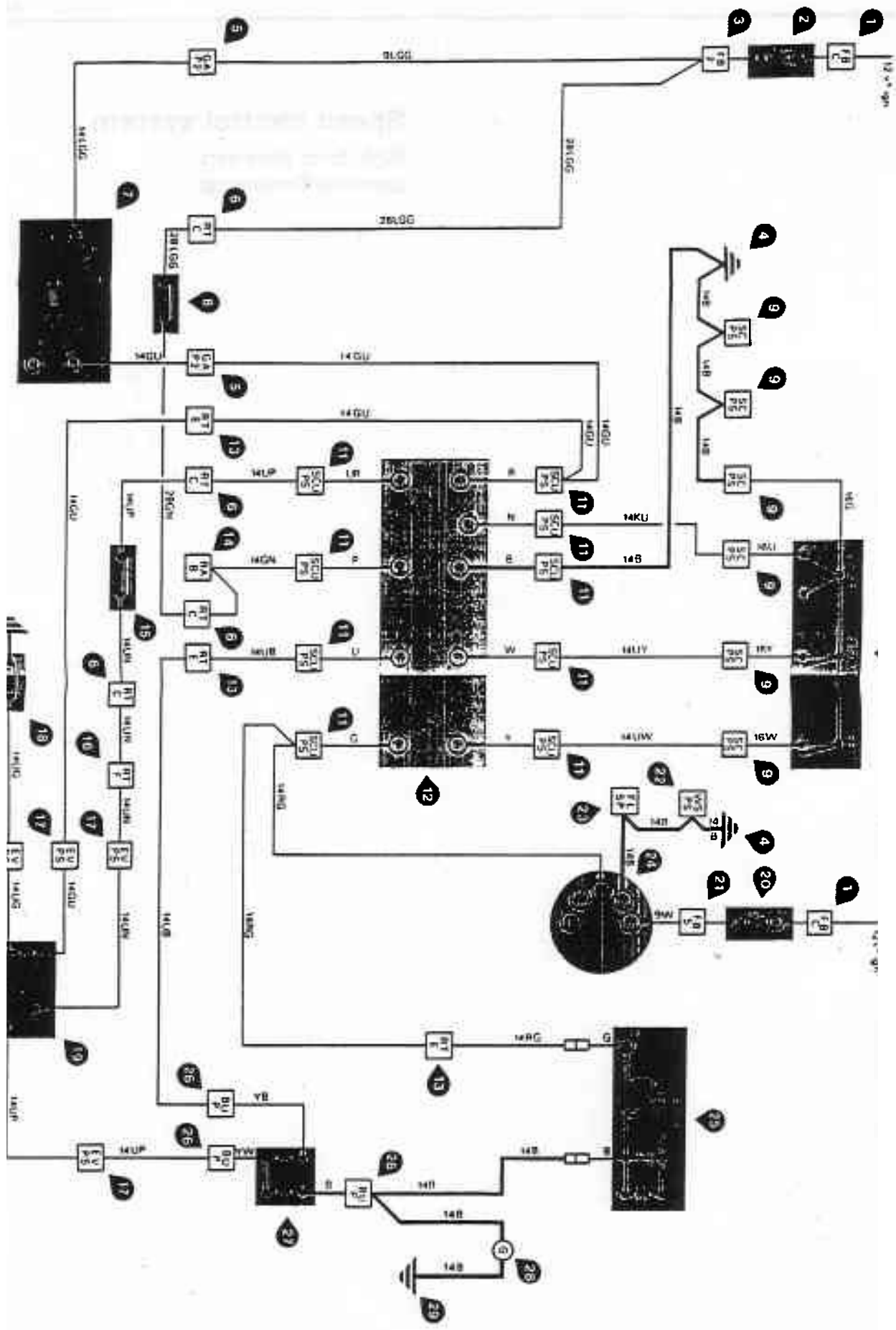

Speed control system

**Left-hand drive cars
Corniche/Continental**

Wiring diagram

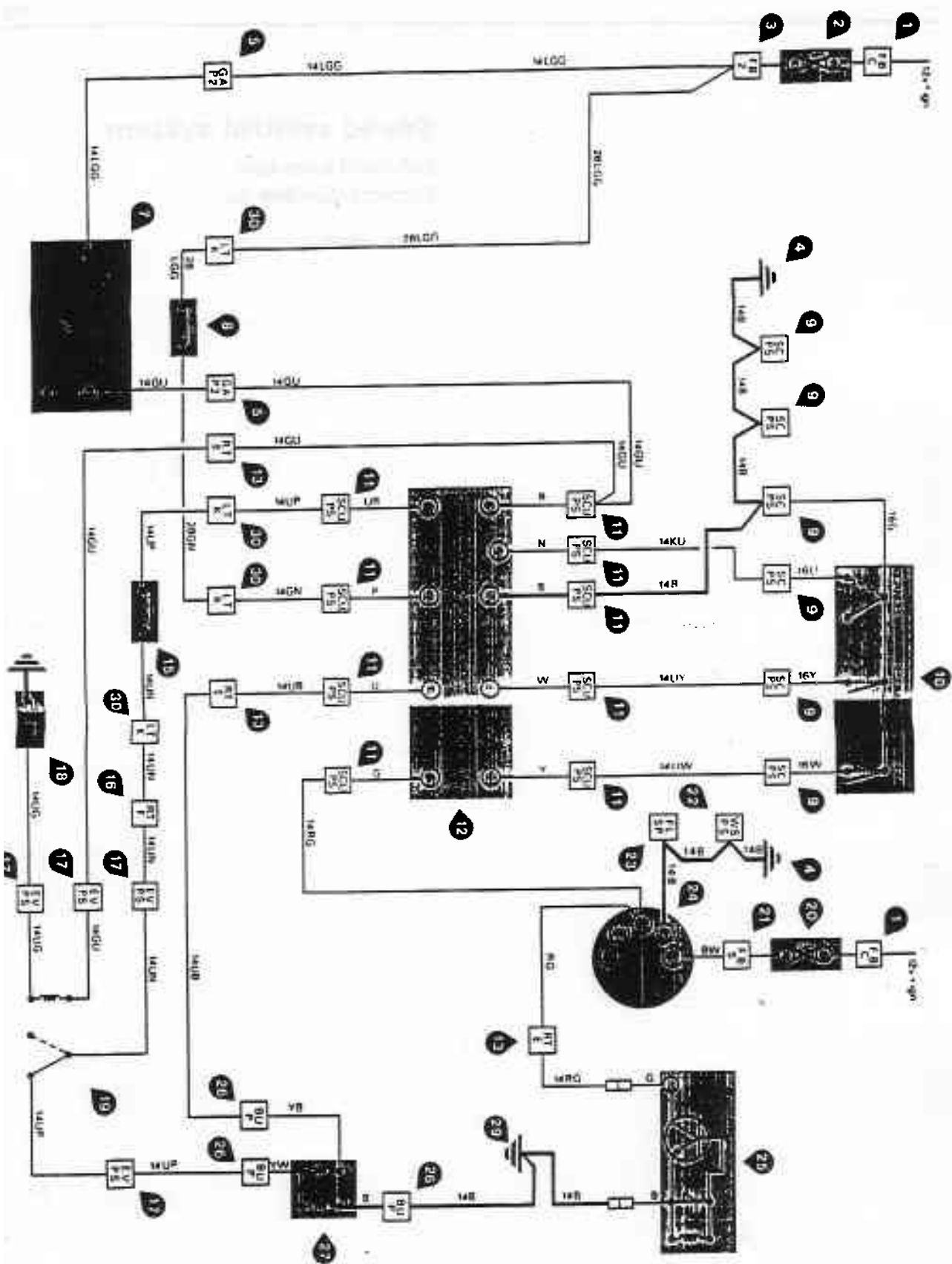

Cruise Control System – Cars from Chassis 20,000

**Including Electric Servo-Controlled Cruise Control and VDO 412 212/4/1
Electronic Control Unit**

Note that the ECU may be replaced by the unit used in General Motors Vehicles, VDO Part Number 412 212/4/1 or GM Europe part number 90213458.

Cruise control system (Key to 26-3)

Component locations

002748

Wiring diagram

002749

- 1) 'A' post earth points
- 2) Cruise control actuator
- 3) Boost control electronic control unit. Bentley Turbo R cars
- 4) Stop lamps switch
- 5) Cruise control actuator plug and socket 7-way
- 6) Engine loom to boost control electronic control unit loom plug and socket 7-way
- 7) Valance loom to brake switches loom plug and socket 5-way
- 8) Main loom to valance loom plug and socket 9-way - right-hand 'A' post
- 9) Valance loom to engine loom plug and socket 18-way - right-hand side
- 10) Valance loom to engine loom plug and socket 12-way - left-hand side
- 11) Main loom to valance loom plug and socket 9-way - left-hand 'A' post
- 12) Splice 23. Right-hand drive cars Splice 51. Left-hand drive cars
- 13) Main loom to body loom plug and socket 9-way - right-hand 'A' post
- 14)

003362

On cars other than those conforming to an Australian, Canadian, New Zealand, or USA specification, the relay is not fitted and the green/brown and brown/yellow cables are interlinked at the relay base

- 15) Stop lamps relay or relay base
- 16) Body loom to high mounted stop lamp plug 2-way. Cars conforming to an Australian, Canadian, New Zealand, or USA specification
- 17) High mounted stop lamp. Cars conforming to an Australian, Canadian, New Zealand, or USA specification
- 18) Cruise control electronic control unit plug
- 19) Cruise control electronic control unit
- 20) Cruise control brake switch
- 21) Stop lamp failure amplifier
- 22) Stop lamp failure amplifier plug
- 23) Luggage compartment earth point - right-hand side
- 24) Main loom to valance loom plug and socket 18-way - left-hand 'A' post
- 25) Body loom to luggage compartment lid loom plug and socket 12-way
- 26) Main loom to body loom plug and socket 24-way - right-hand 'A' post
- 27) Left-hand stop lamp
- 28) To instruments module socket 26-way - blue. For further information reference should be made to the wiring diagrams contained within Section 22
- 29) Right-hand stop lamp
- 30) Main loom to speed signal generator loom plug and socket 4-way
- 31) Steering column plug and socket 6-way
- 32) Splice 14. Right-hand drive cars Splice 46. Left-hand drive cars
- 33) Left-hand outer stop lamp. Cars conforming to a Canadian, Japanese, or USA specification
- 34) Splice 153
- 35) Splice 151
- 36) Right-hand outer stop lamp. Cars conforming to a Canadian, Japanese, or USA specification
- 37) Printed circuit board connection
- 38) Cancel switch
- 39) Resume switch
- 40) Set/accelerate switch
- 41) Gearchange actuator plug and socket 6-way - blue
- 42) Luggage compartment lid earth point
- 43) Fuseboard F2, fuse B1, 20 amp
- 44) Speed signal generator
- 45) Gearchange actuator 'reverse' micro-switch
- 46) Gearchange actuator 'RDIL' micro-switch
- 47) Body loom to luggage compartment lid loom plug and socket 3-way
- 48) Boost control electronic control unit plug 25-way. Bentley Turbo R cars

Note:
003363
Only applicable to Bentley Turbo R cars

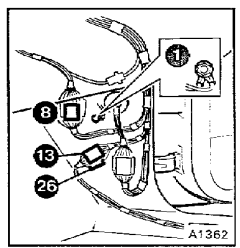
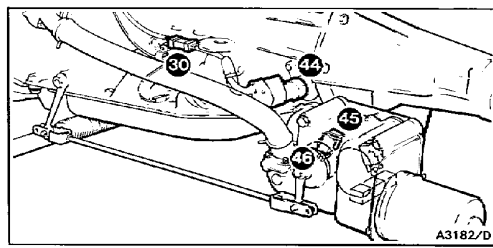
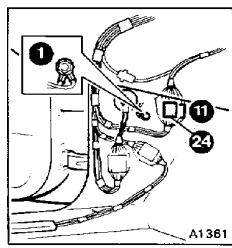
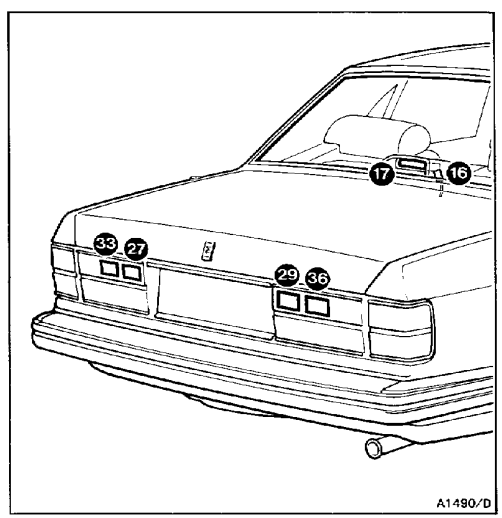
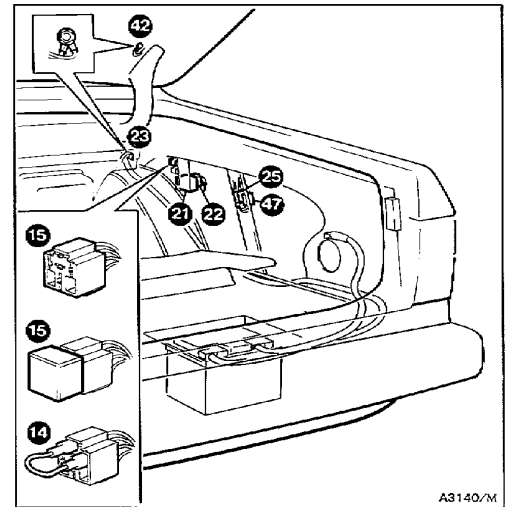
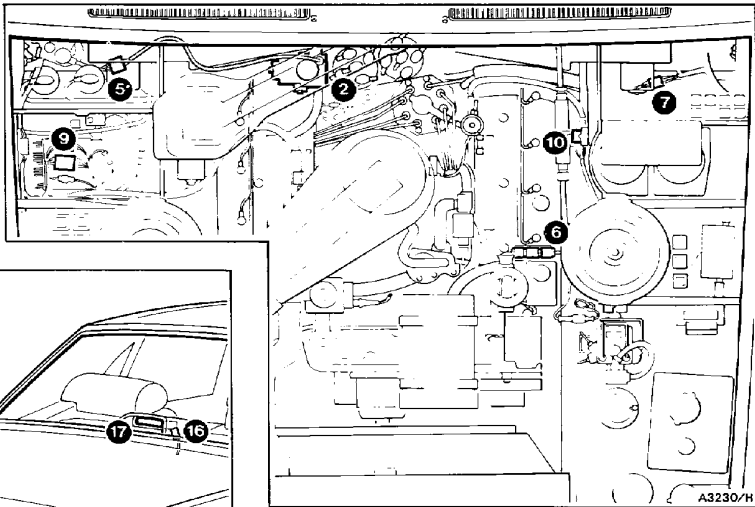
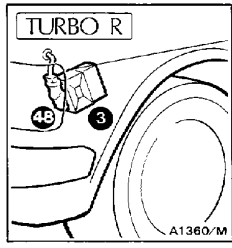
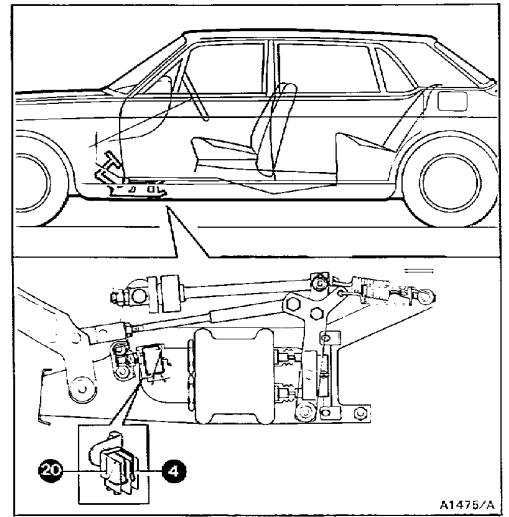
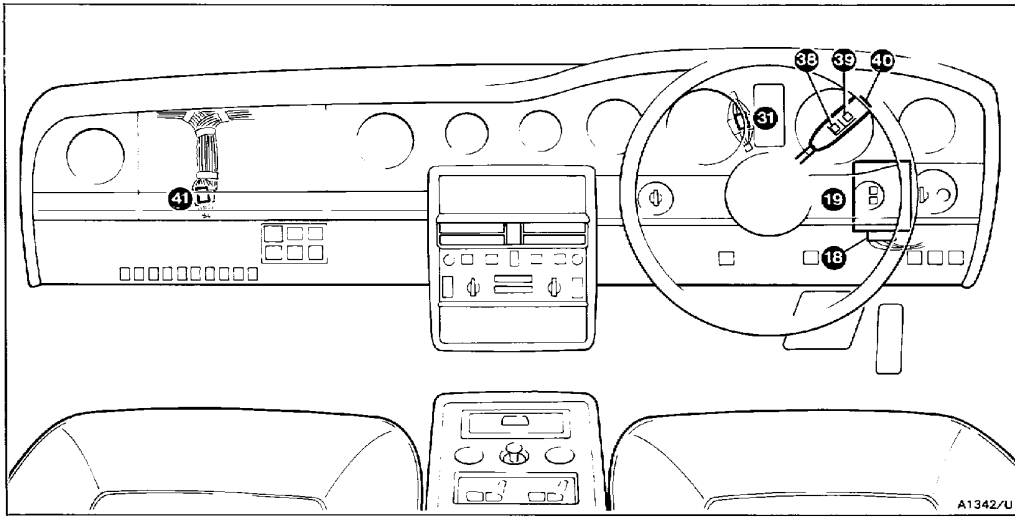

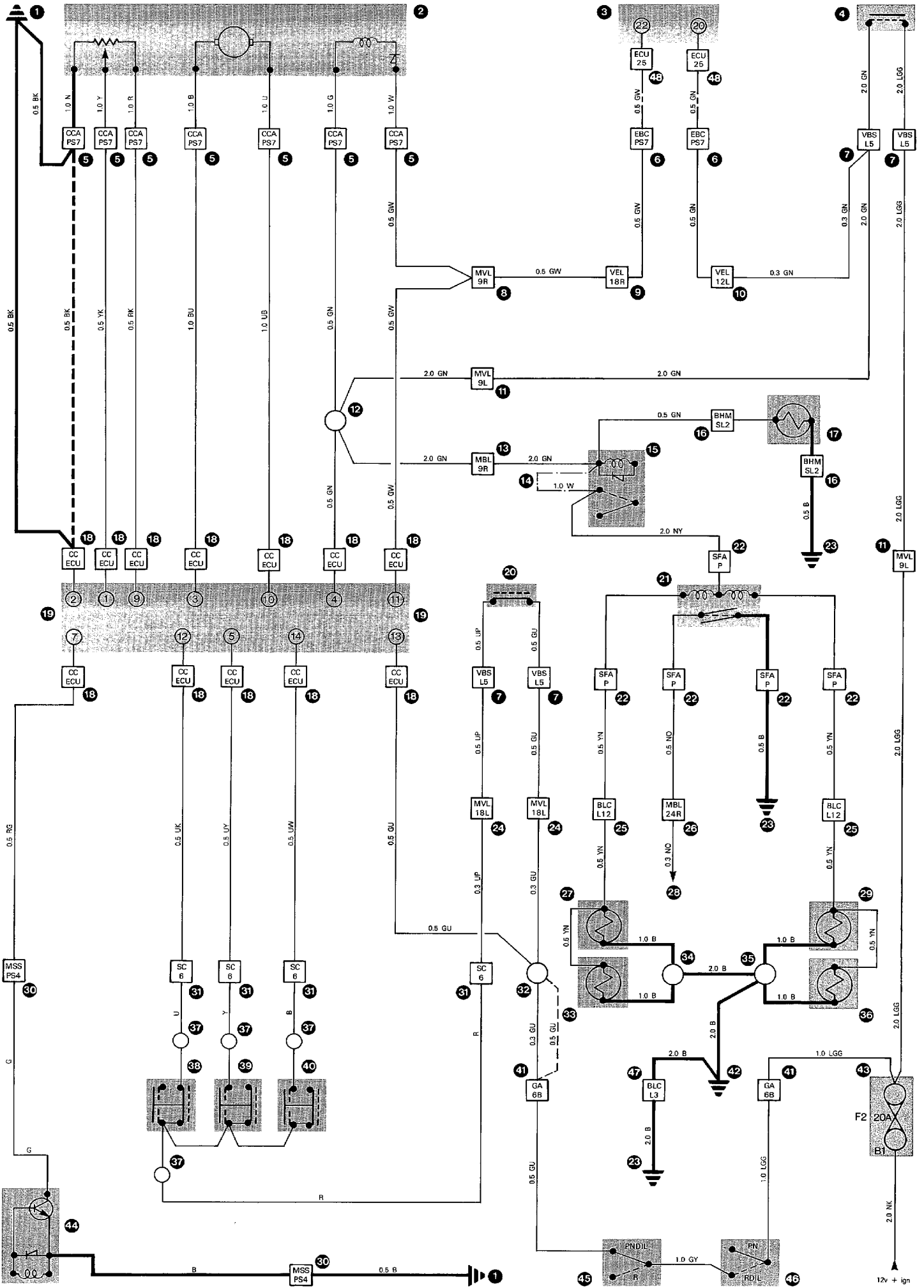





Windscreen wipers and washers

Contents	Pages					
	Silver Spirit Mulsanne	Silver Spur	Mulsanne Turbo	Bentley Eight	Bentley Turbo R	Corniche/ Continental
Cars prior to vehicle identification number * SCAZS42A3FCX12001*						
Component location	M9-3	M9-3	M9-3	M9-3	—	—
Wiring diagram and circuit description, OFF position 1	M9-5	M9-5	M9-5	M9-5	—	—
Wiring diagram and circuit description, OFF position 2	M9-7	M9-7	M9-7	M9-7	—	—
Wiring diagram and circuit description, SLOW position	M9-9	M9-9	M9-9	M9-9	—	—
Wiring diagram and circuit description, FAST position	M9-11	M9-11	M9-11	M9-11	—	—
Wiring diagram and circuit description, INT (Intermittent) position	M9-13	M9-13	M9-13	M9-13	—	—
Wiring diagram and circuit description, WASH/WIPE mode	M9-15	M9-15	M9-15	M9-15	—	—
Cars from vehicle identification number * SCAZS42A3FCX12001*						
Component location	M9-17	M9-17	M9-17	M9-17	M9-17	M9-29/1
Wiring diagram and circuit description, OFF position 1	M9-19	M9-19	M9-19	M9-19	M9-19	M9-29/3
Wiring diagram and circuit description, OFF position 2	M9-21	M9-21	M9-21	M9-21	M9-21	M9-29/5
Wiring diagram and circuit description, SLOW position	M9-23	M9-23	M9-23	M9-23	M9-23	M9-29/7
Wiring diagram and circuit description, FAST position	M9-25	M9-25	M9-25	M9-25	M9-25	M9-29/9
Wiring diagram and circuit description, INT (Intermittent) positions	M9-27	M9-27	M9-27	M9-27	M9-27	M9-29/11
Wiring diagram and circuit description, WASH/WIPE mode	M9-29	M9-29	M9-29	M9-29	M9-29	M9-29/13
Windscreen wipers electronic control unit test procedure	M9-31	M9-31	M9-31	M9-31	M9-31	M9-31

From VIN *SCAZS0006GCX13860* (excluding Corniche/Continental) and with the exception of VIN *SCAZN0004FCH14000* to VIN *SCAZN0009FCH14025* inclusive, a new type of fuseboard is fitted incorporating Littell or Buss fuses (these fuses are not interchangeable with Bulgin type fuses).

Therefore when working to a wiring diagram or component location showing the earlier Bulgin type of fuse, reference must be made to the following table for its equivalent.

Circuits controlled	Bulgin fuse number 	Littell or Buss fuse number and fuseboard identification 	Fuse rating (amps)	Circuits controlled	Bulgin fuse number 	Littell or Buss fuse number and fuseboard identification 	Fuse rating (amps)
Cellular telephone when fitted	—	A1 - F2	4A	Rear window demister and mirror heaters	11	B4 - F3	20A
Cellular telephone when fitted	—	A2 - F2	10A	Reverse lamps, stoplamps, speed control, headlamp wash	10	B3 - F3	20A
Interior lamps	1	A6 - F2	10A	Direction indicators, headlamp flash, fuel door, horns control	14	B2 - F3	20A
Radio, panel illumination, ACU control	20	B1 - F2	10A	Cigar lighters, clock, aerial, fuel door	7	C4 - F3	20A
Radio amplifier when fitted	19	B2 - F2	10A	Engine cooling fan	2	C1 - F3	20A
Starter, ignition, fuel pump	27	B3 - F2	10A	Engine cooling fan	9	C1 - F3	20A
Instruments and warning lamps	28	B4 - F2	10A	Wipers and washers	5	B1 - F3	20A
ACU control	8	B5 - F2	10A	Spare	—	B6 - F3	20A
Spare	—	B6 - F2	10A	Fuel pump	13	B5 - F3	20A
L.H. Tail lamp	15	C1 - F2	10A	Horns	3	C3 - F3	20A
R.H. Tail lamp	22	C2 - F2	10A	Fog lamps when fitted	12	C6 - F3	20A
Parking lamps, number plate lamps, W.L. dim control	16	C3 - F2	10A	Air horns when fitted	4	C5 - F3	20A
L.H. Dip beam	24	C4 - F2	10A	Hazard warning	6	C2 - F3	20A
R.H. Dip beam	25	C5 - F2	10A				
Spare	—	C6 - F2	10A				
Spare	—	A6 - F3	20A				

For fuse identification refer to Section M1, General information, page M1-3.

Windscreen wipers and washers

Component location

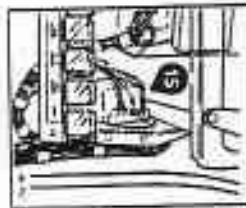
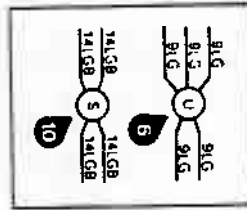
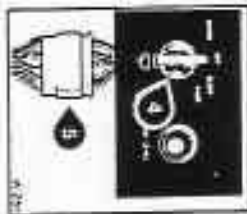
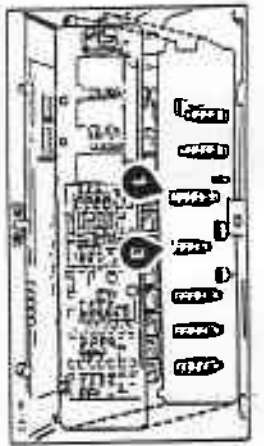
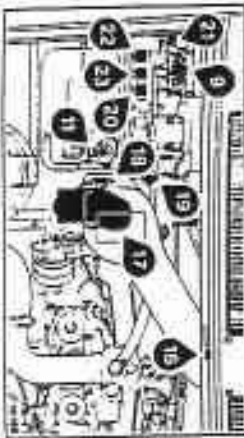
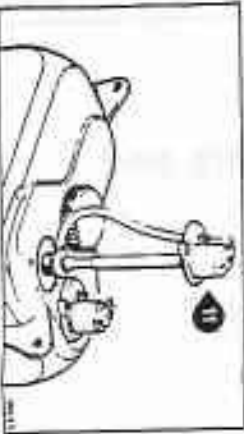
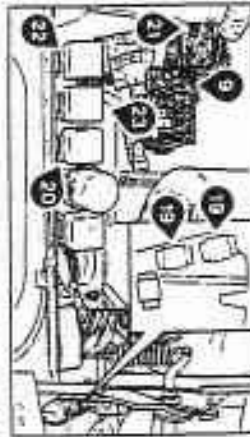
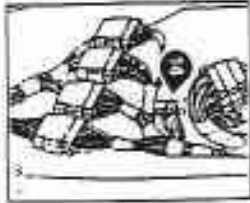
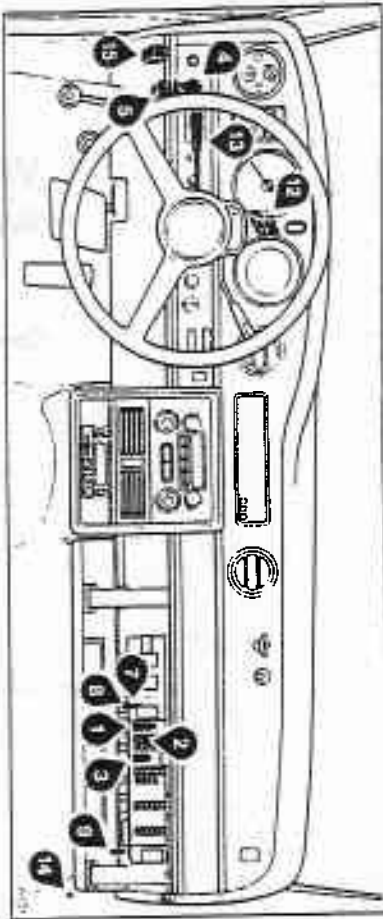
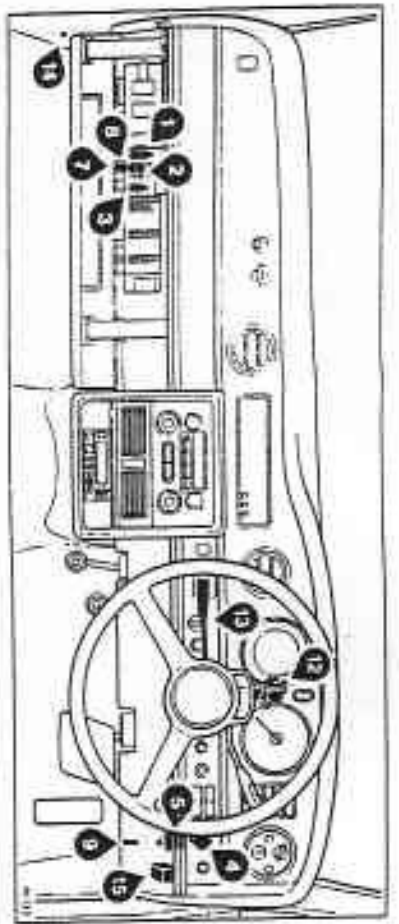

Callout	Part Name	Part Number
1
2
3
4
5
6
7
8
9
10
11
12
13
14
15
16
17
18
19
20
21
22
23
24
25
26
27
28
29
30
31
32
33
34
35
36
37
38
39
40
41
42
43
44
45
46
47
48
49
50
51
52
53
54
55
56
57
58
59
60
61
62
63
64
65
66
67
68
69
70
71
72
73
74
75
76
77
78
79
80
81
82
83
84
85
86
87
88
89
90
91
92
93
94
95
96
97
98
99
100

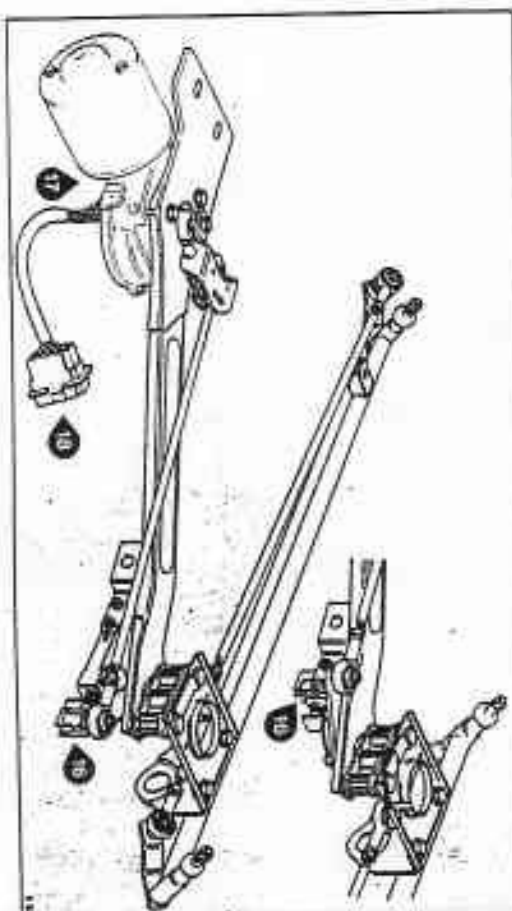
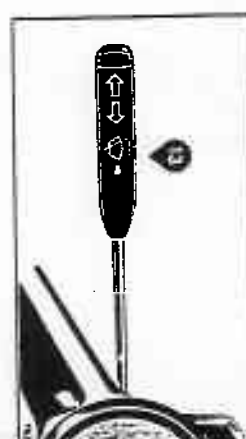
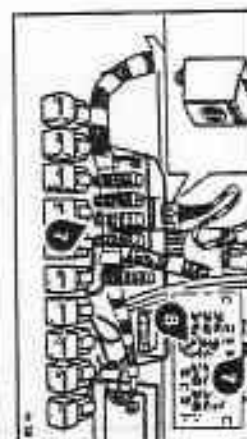

Windscreen wipers and washers

OFF position 1

• **Wiring diagram and circuit description**

Circuit description

OFF position

With the windscreen wiper control switch in the OFF position, switch contacts 1 and 2 are closed. If the screen wiper system is operating and OFF position is then selected the wiper motor continues to rotate until the motor sets the 'Park on screen' switch (within the motor assembly) to the Park position. This breaks the 12 volts positive supply to the coil of relay 1, thereby de-energizing the relay and removing the 12 volts positive supply from the slow speed brush of the wiper motor. This supply to the motor is routed from fuse 5 at the fuseboard via right-hand toeboard plug B and also the connection at relay 2 socket.

The slow speed brush of the wiper motor now finds an earth path through the normally closed contacts of relays 3 and 1, and via connections at relay sockets 1, 2, and 3 to the valance earth point.

The coil of relay 2 receiving 12 volts positive from wiper switch contact 2, finds an earth path via the Run position of the 'Park off screen' switch, thereby energizing relay 2. This provides a 12 volts positive supply through the normally open contacts to the wiper motor. The motor reverses direction, causing the 'Park off screen' switch to be set to the Park position. This disconnects the earth path causing the motor to stop with the windscreen wiper blades in the parked position.

Switch position	Terminals connected
	1-2
	1-1
	1-2, 3-4
	1-3, 7-8, 9-10
	1-E, 7-E, 9-11
	1-E, 7-8, 9-12
	1-3, 7-8, 9-13

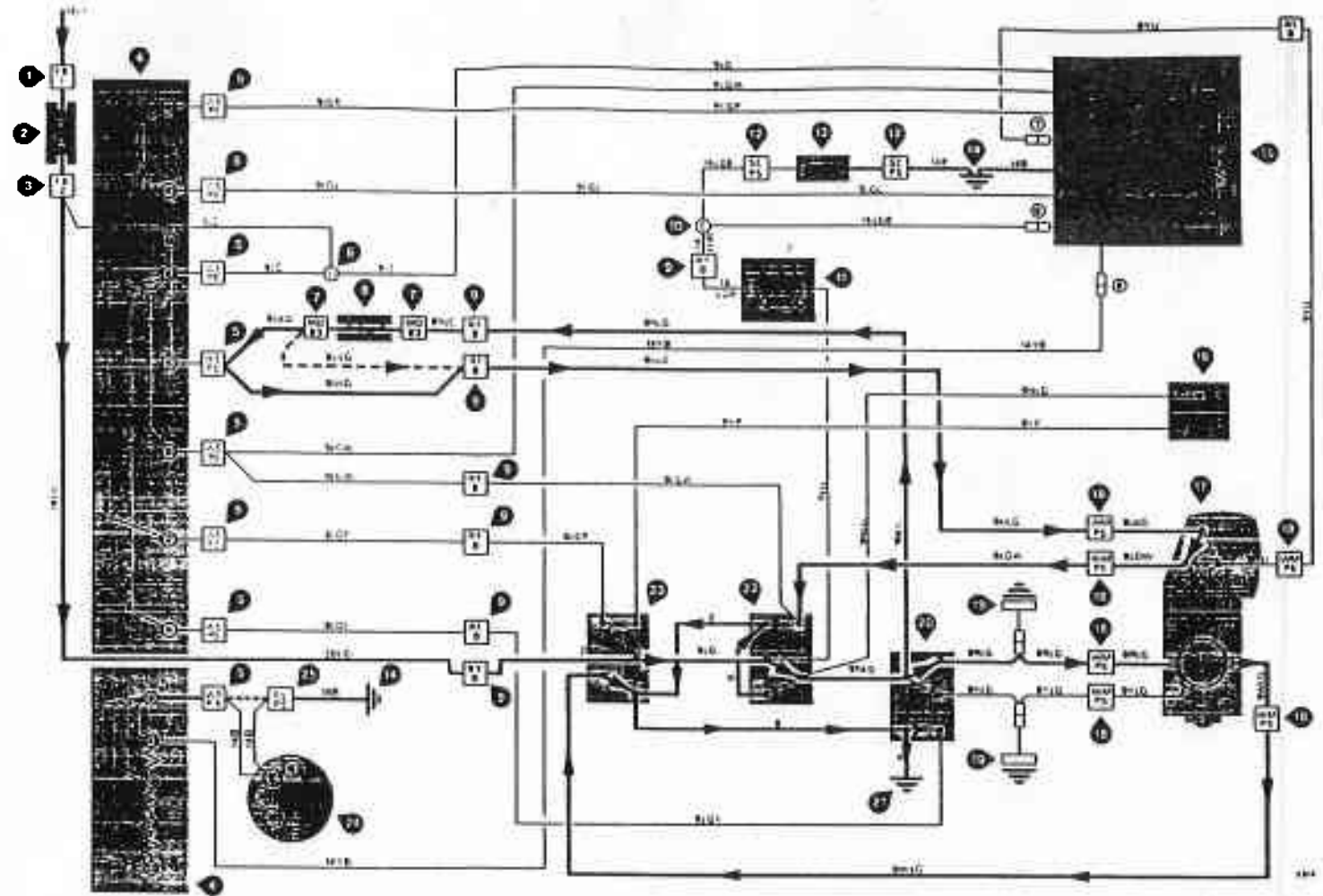

Windscreen wipers and washers

OFF position 2

Wiring diagram and circuit description

Circuit description

Off position
 With the windscreen wiper control switch in the Off position, switch contacts 1 and 2 are closed. If the screen wiper system is operating and Off position is then selected the wiper motor continues to rotate until the motor sets the 'Park on screen' switch (within the motor assembly) to the Park position. This breaks the 12 volts positive supply to the coil of relay 1, thereby de-energizing the relay and removing the 12 volts positive supply from the slow speed brush of the wiper motor. This supply to the motor is routed from fuse 5 at the fuseboard via right-hand toeboard plug B and also the connection at relay 2 socket.

The slow speed brush of the wiper motor now finds an earth path through the normally closed contacts of relays 3 and 1, and via connections at relay sockets 1, 2, and 3 to the valance earth point.

The coil of relay 2 receiving 12 volts positive from wiper switch contact 2, finds an earth path via the Run position of the 'Park off screen' switch, thereby energizing relay 2. This provides a 12 volts positive supply through the normally open contacts to the wiper motor. The motor reverses direction, causing the Park off screen switch to be set to the Park position. This disconnects the earth path causing the motor to stop with the windscreen wiper blades in the parked position.

Switch position	Terminals connected
	1-2
	1-3
	1-4
	1-5, 7-8, 9-10
	1-6, 7-8, 9-10
	1-9, 7-8, 9-10
	1-10, 7-8, 9-10
	1-11, 7-8, 9-10
	1-12, 7-8, 9-10

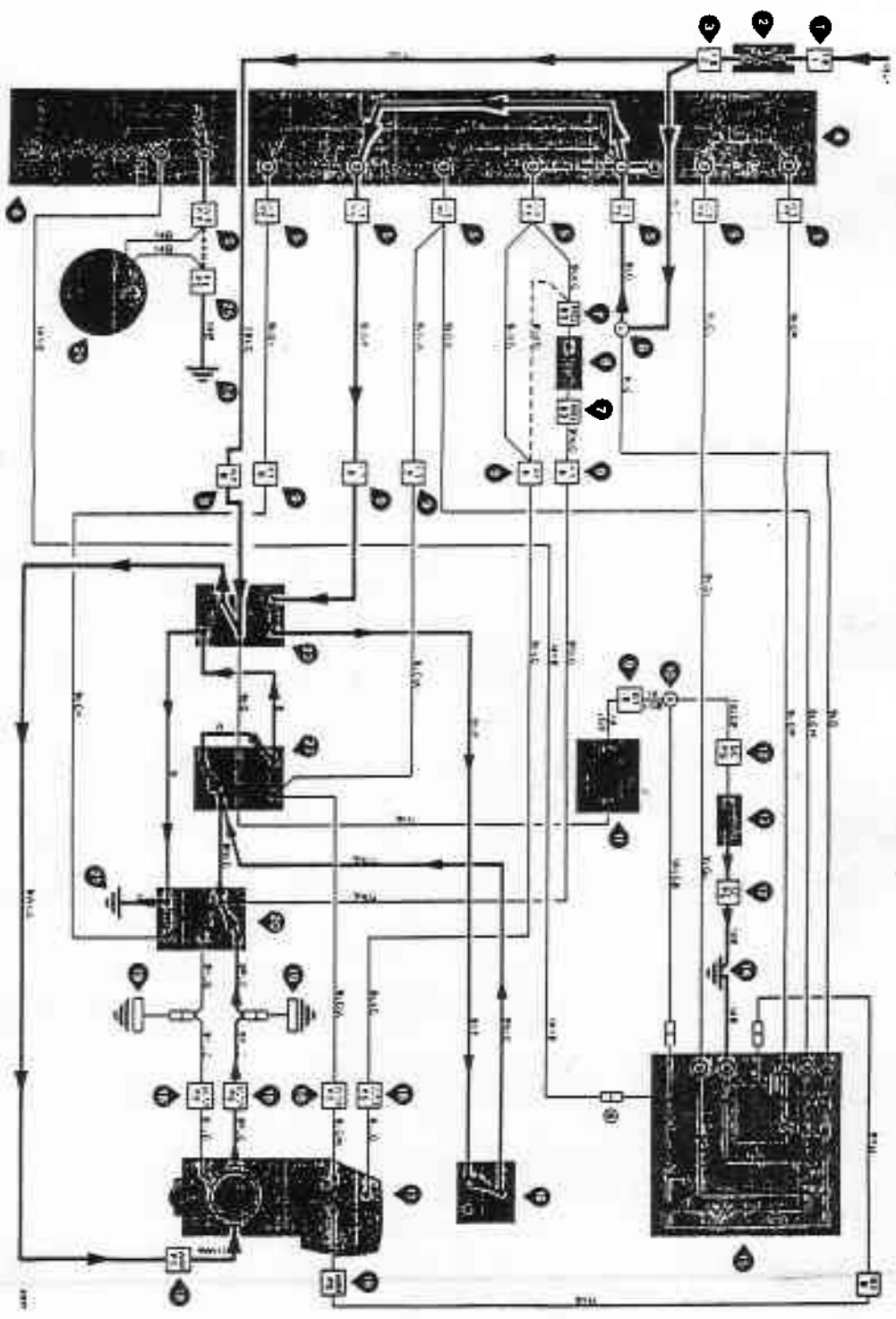

Windscreen wipers and washers

SLOW position

Wiring diagram and circuit description

Circuit description

SLOW speed position
 With the windscreen wiper control switch in the SLOW position, switch contacts 1 and 3 are closed. A 12 volt positive supply from fuse 5 at the fuseboard is directed through switch contacts 1 and 3 to energize relay 1. This allows a 12 volt positive supply and via the normally open contacts of relay 1 slow speed brush of the wiper motor. The supply is routed from fuse 5 at the fuseboard via right-hand socket. The earth path for the wiper motor is via the normally closed contacts of relay 2, and the connection at relay 3 socket, to the valance earth point.

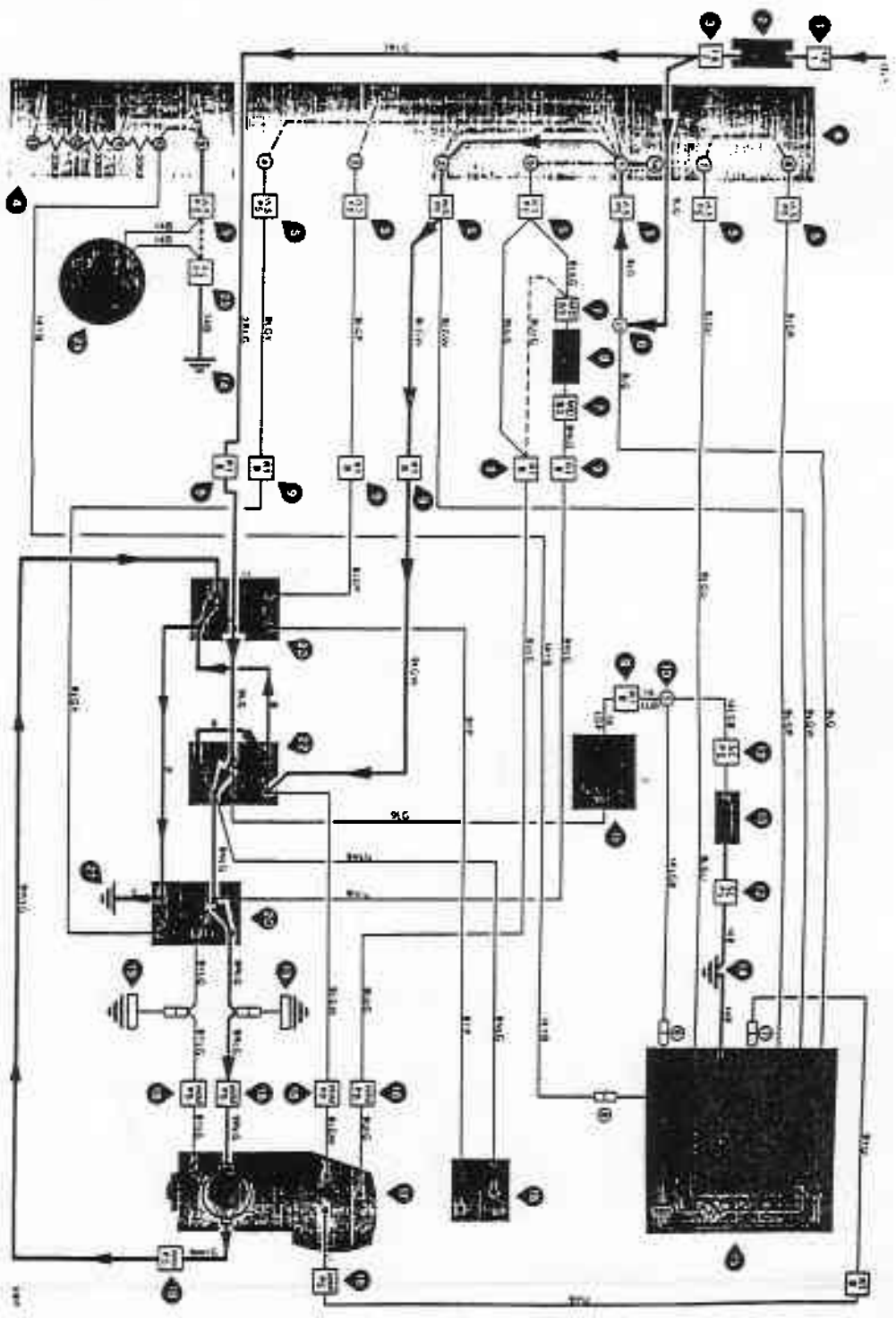
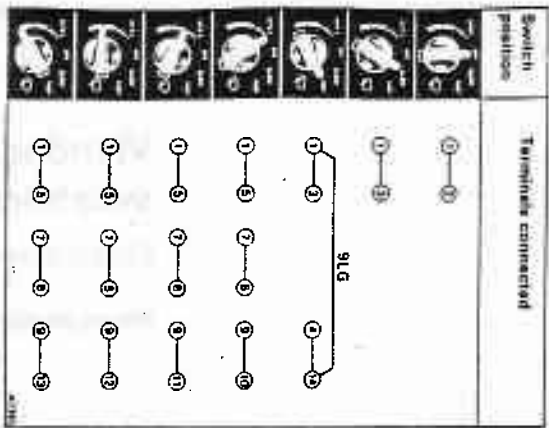

Windscreen wipers and washers

FAST position

Wiring diagram and circuit description

Circuit description

FAST position
 With the windscreen wiper control switch set to the FAST position, switch contacts 1, 3, 4, and 14, are closed. A 12 volts positive lead from fuse 5 at the fuseboard is directed via switch contacts 1 and 3 to energize relay 1 and close the normally open contacts. Simultaneously switch contacts 1 and 4 supply 12 volts positive from fuse 5 to energize relay 3. With relay's 1 and 3 energized 12 volts positive is passed through the normally open contacts of the relays to the fast speed brush of the wiper motor. This supply is routed from fuse 5 at the fuseboard via right-hand loeboard plug B and also the connection at relay 2 socket. The earth path for the wiper motor is via the normally closed contacts of relay 2 and the connection at relay 3 socket to the valance earth point.

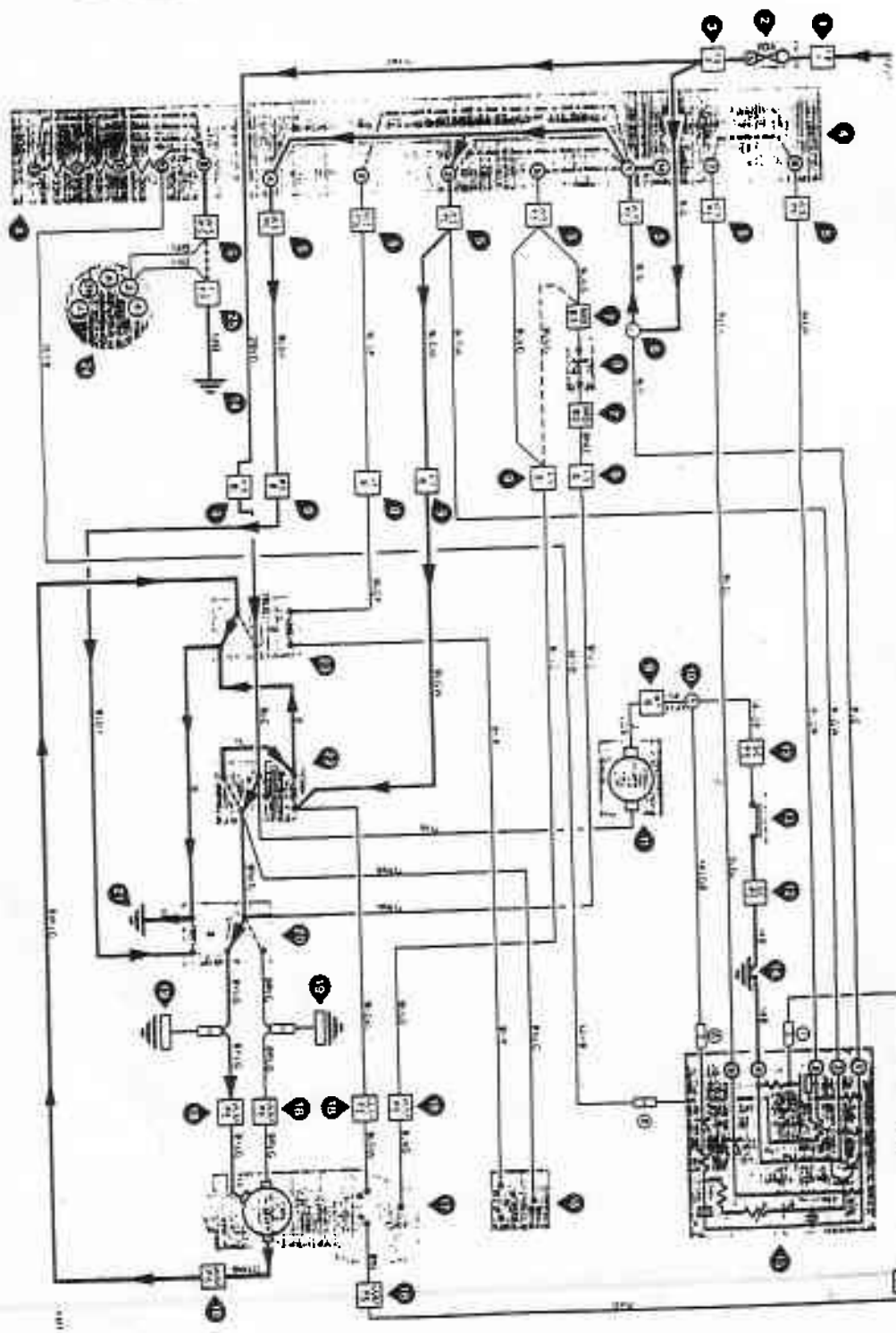
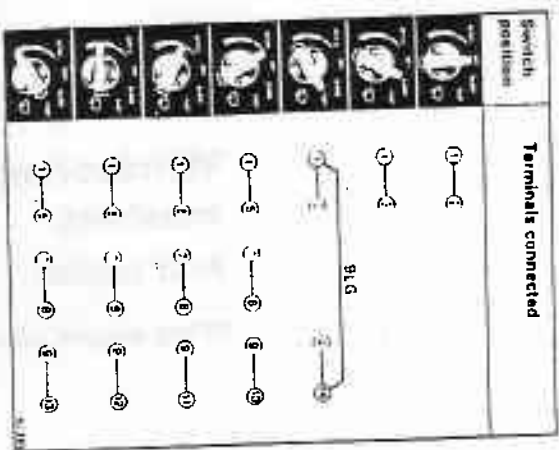

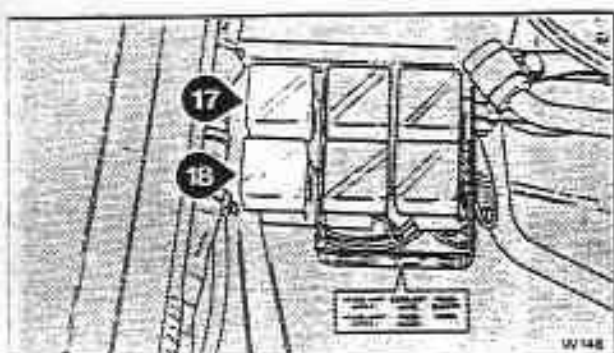
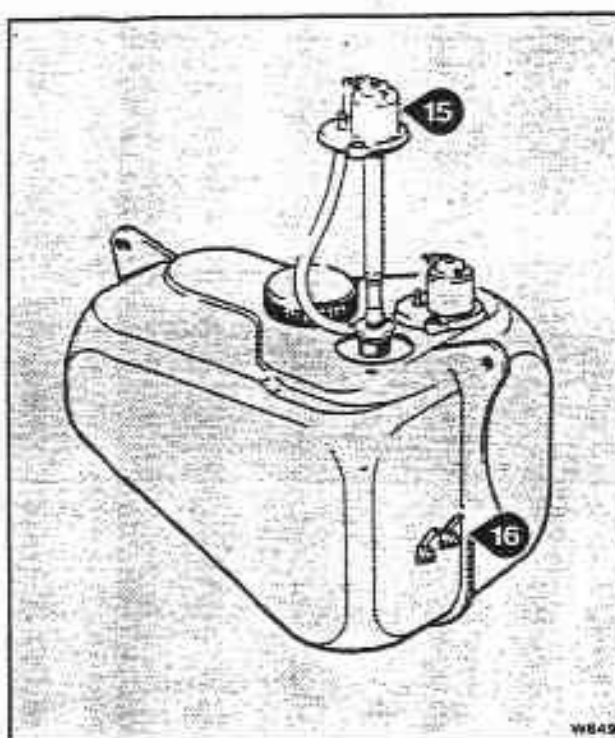
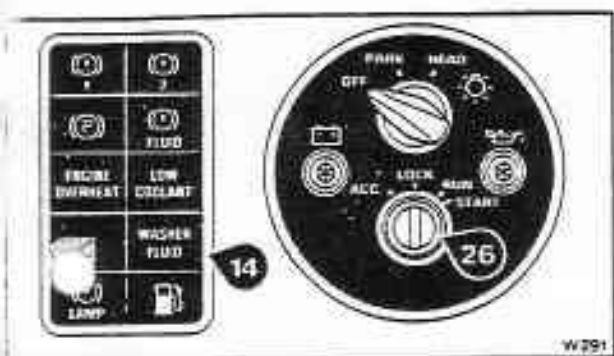
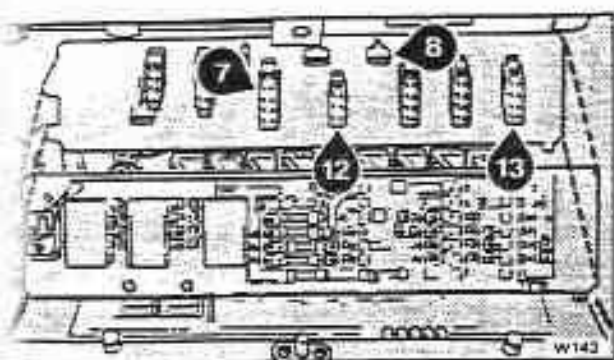

Windscreen wipers and washers

Wash/Wipe mode

Wiring diagram and circuit description

Circuit description

Wash/wipe mode

With the ignition switch in the RUN or ACC position the screen washer pump receives a 12 volts positive supply from fuse 5 at the fuseboard. Depressing the wash/wipe switch on the steering column provides an earth path for the pump which then operates.

The wash/wipe switch also provides an earth path via splice connection S for the light green/black flying lead of the wiper system electronic control unit. This (after a delay of approximately 0.5 sec) provides a 12 volts positive supply at terminal 2 of the control unit, energizing relay 1 and thereby allowing 12 volts positive through the normally open contacts of relay 1, and through the normally closed contacts of relay 3, to the slow speed brush of the wiper motor. This supply is routed from fuse 5 at the fuseboard via toeboard plug B and also the connection at relay 2 socket. The earth path for the wiper motor is directed through the normally closed contacts of relay 2 and the connection at relay 3 socket to the valence earth point.

On releasing the wash/wipe switch the screen wash pump stops immediately, but the wiper system control unit maintains the 12 volt positive supply at terminal 2 for a further five seconds causing the wiper motor to complete approximately five cycles. The wipe cycle ends with the wiper blades in the parked position, details of which are shown in the diagrams for the OFF position.

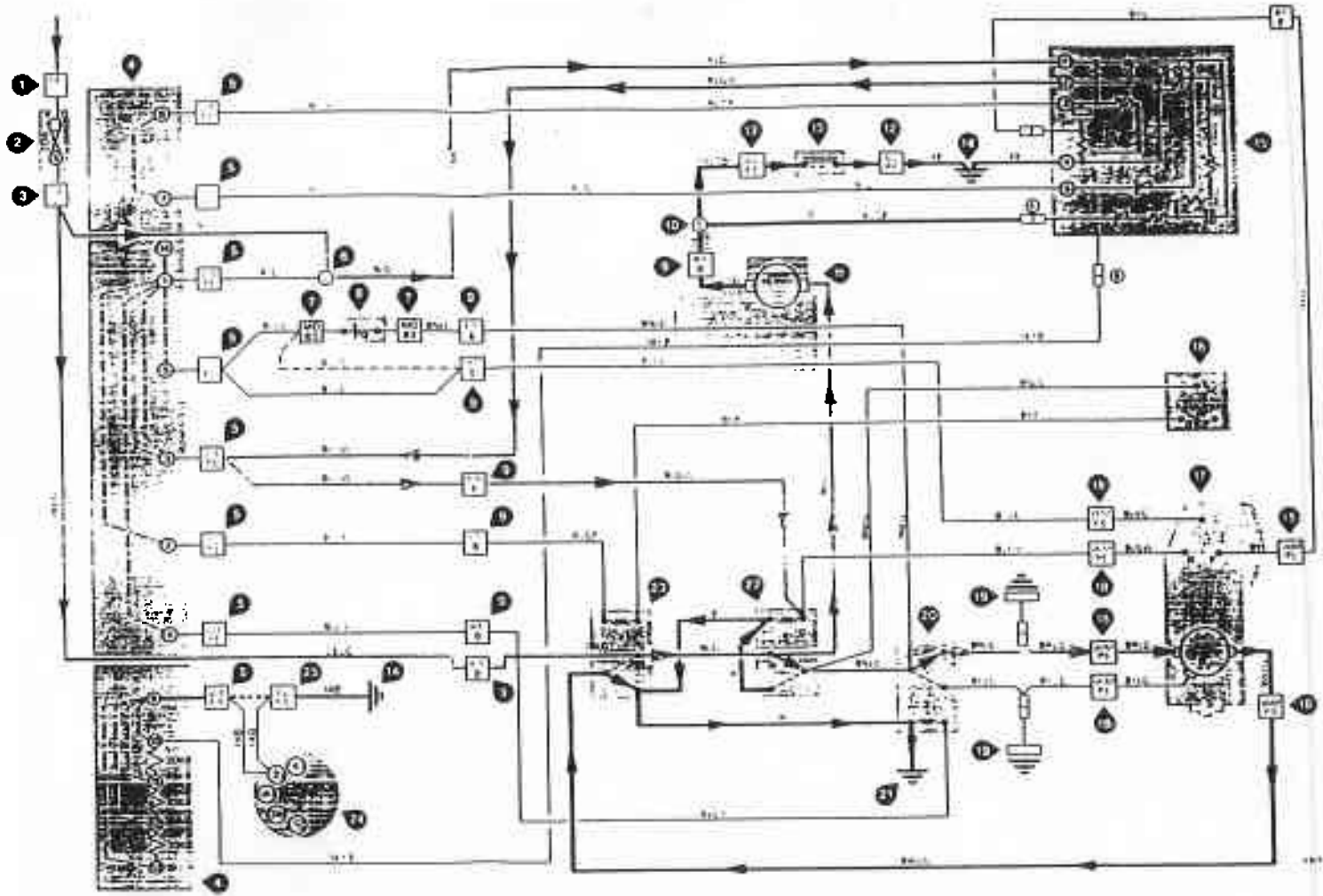

Windscreen wipers and washers

Corniche/Continental
SLOW position

Wiring diagram and circuit description

Circuit description

BLDM speed position
With the windtween wiper contact switch in the SLOW position switch contacts 1 and 3 are closed. A 17 volt positive supply from fuse 5 at the fuseboard is directed through switch contacts 1 and 3 to energize relay 1. This allows a 12 volt positive supply to pass through the normally open contacts of relay 1 and via the normally closed contacts of relay 3 to the slow speed brush of the wiper motor. The supply is routed from fuse 5 at the fuseboard via right-hand loadeboard plug B and also the connection at relay 2 socket. The earth path for the wiper motor is via the normally-closed contacts of relay 2 and the connection at relay 3 socket to the valence earth point.

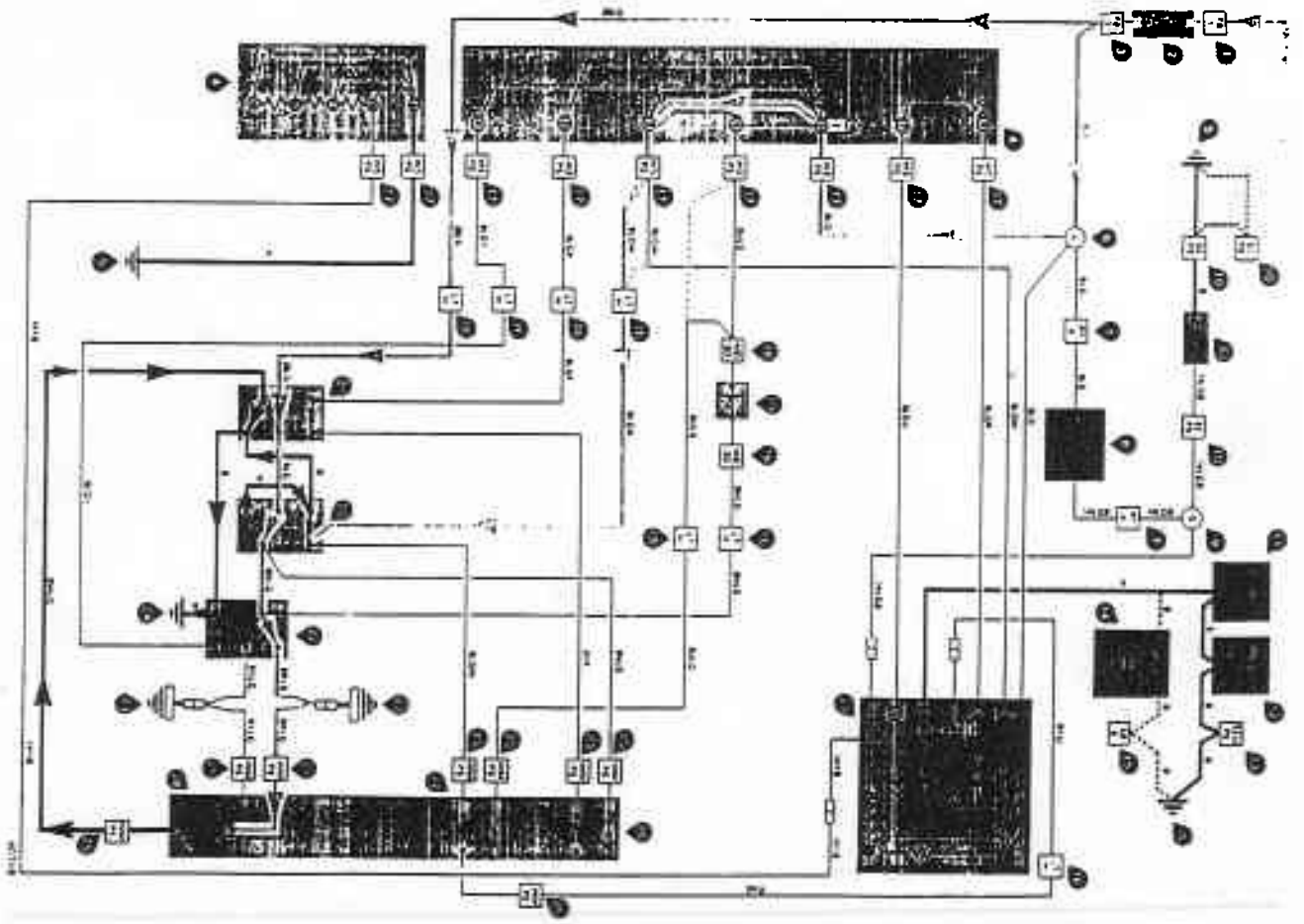

Windscreen wipers and washers

Corniche/Continental

FAST position

Wiring diagram and circuit description

Circuit description

FAST position
With the windscreen wiper control switch set to the FAST position, switch contacts 1, 3, 4, and 14 are closed. A 12 volt positive lead from fuse 5 in the fuseboard is directed via switch contacts 1 and 3 to energise relay 1 and close the normally open contacts simultaneously switch contact 1 and 4 supply 12 volt positive from fuse 5 to energise relay 3. With relay 1 and 3 energised 12 volt positive is passed through the normally open contacts of the relay to the fan speed brush of the wiper motor. The supply is pulled from bus 31, the loadboard via right-hand terminal 1, plug 18 and also the connection at relay 2. The earth path for the wiper motor is via the normally closed contacts of relay 2 and the connection at relay 3, 34, still to the valance earth point.

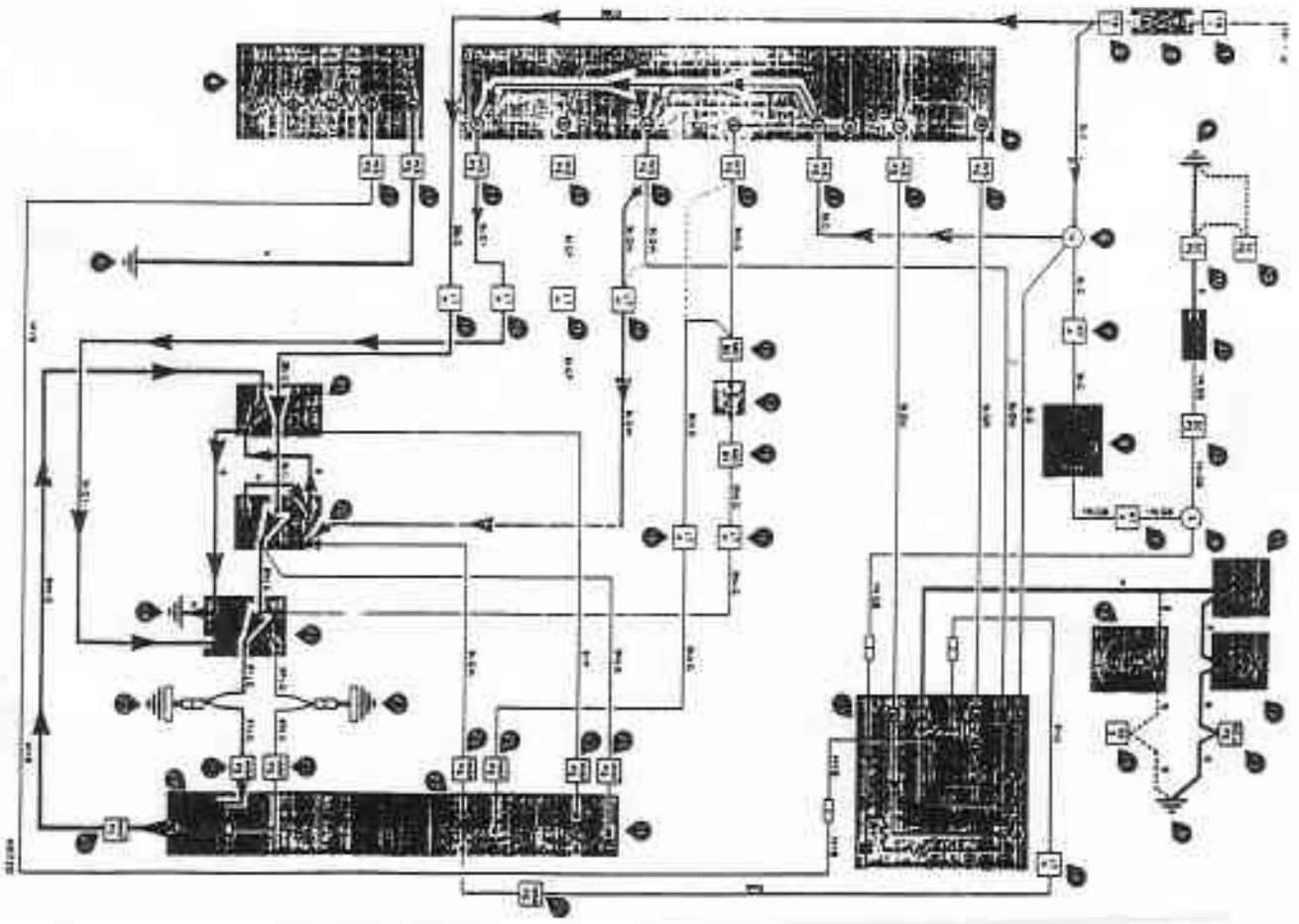

Windscreen wipers and washers

Corniche/Continental

INTER (Intermittent) positions

Wiring diagram and circuit description

Circuit description

4 position INTER (Intermittent) wipe
 When the windshield wiper control switch in the INTER (Intermittent) wipe position 1, the switch contacts 1 and 5, 7 and 8, also 9 and 10 are closed (except for the closed contacts the current supply flow for each intermittent wipe position remains the same as in position 1).

When the switch contacts 7 and 8 are closed the wiper system electronic control unit provides a momentary 12 volt positive supply at terminal 2 of the unit to energize the coil of relay 1. With relay 1 energized a 12 volt positive supply is directed to the normally open contacts of relay 1 and through the normally closed contacts of relay 3 to the slow speed brush of the wiper motor. This supply is routed from tube 5 at the keyboard via terminal plug B and also the connection at relay 2 socket. The earth path for the wiper motor is directed through the normally closed contacts of relay 2 and the connection at relay 3 socket to the valve earth point. The motor then rotates.

Immediately, the motor rotates, the Park on screen switch is set to the Run position and a 12 volt

positive supply is fed via the Run position 12 volts positive at the coil of relay 1.

After one wipe cycle the motor sets the Park on screen switch to the Park position, thus de-energizing relay 1 and disconnecting the motor supply. The motor stops with the screen wiper blades in the Park on screen position.

After the appropriate switch position time delay (ie position 1 three seconds, position 2 seven seconds, position 3 fourteen seconds, position 4 twenty one seconds), the electronic control unit of the system again sets a momentary 12 volts positive supply at terminal 2 causing the cycle to be repeated.

The intermittent wipe cycle continues until the windshield wiper control switch is set to the OFF position.

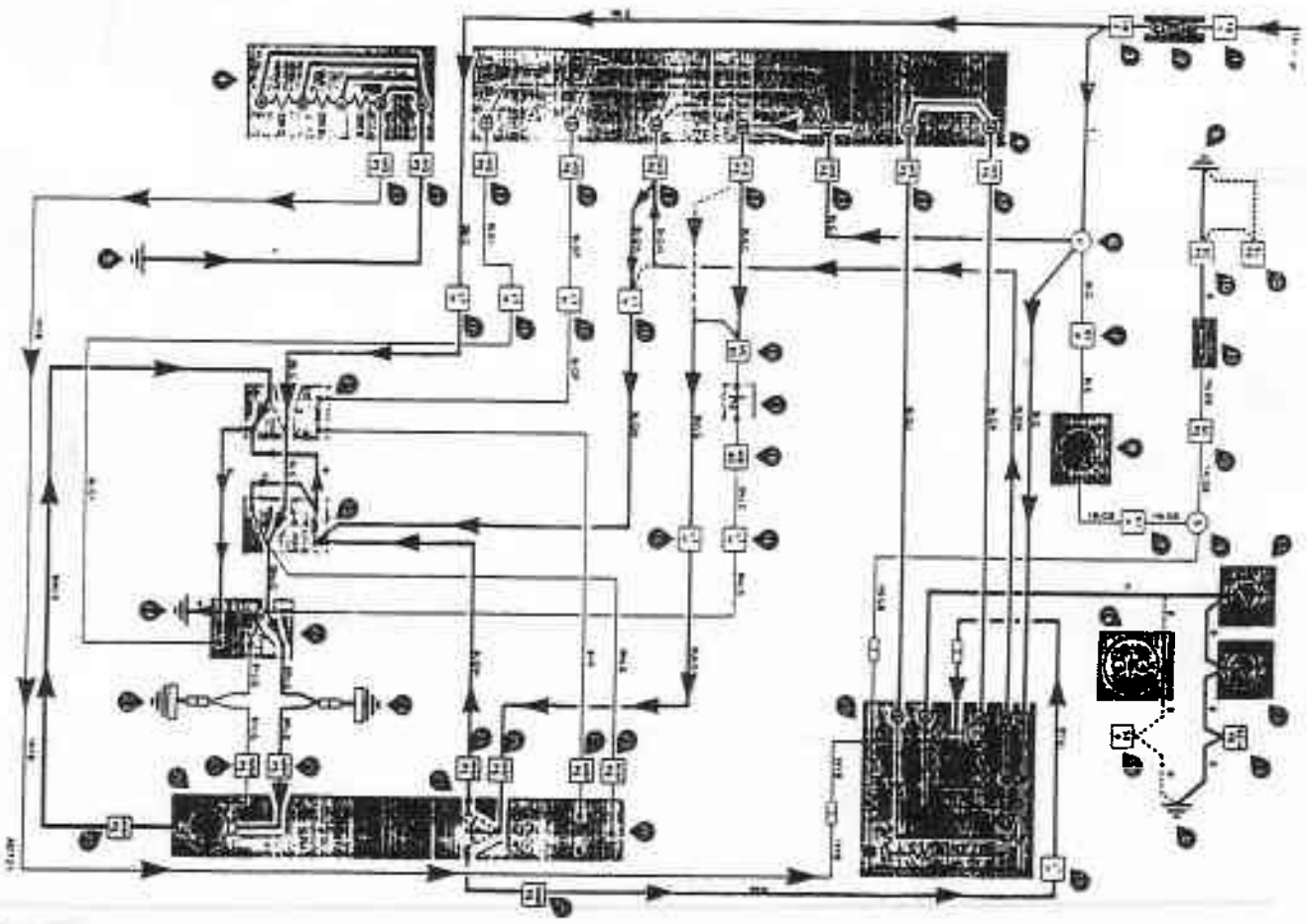

Windscreen wipers and washers

Corniche/Continental
Wash/wipe mode

Wiring diagram and circuit description

Circuit description
Wash/wipe mode

When the ignition switch is in the RUN or ACC position the screen washer pump receives a 12 volt positive supply from fuse 5 in the fuseboard. Depressing the wash/wipe switch on the steering column provides an earth path for the pump which then operates. The wash/wipe switch also provides an earth path via solenoid connection 5 for the light green black flying lead of the wiper system electronic control unit. This latter a delay of approximately 0.5 sec] provides a 12 volt positive supply at terminal 2 of the control unit, energizing relay 1 and thereby allowing 12 volts positive through the normally open contacts of relay 1 and through the normally closed contacts of relay 3 to the slow speed brush of the wiper motor. This supply is routed from fuse 5 at the fuseboard via toolbar plug B and also the connection at relay 2 socket. The

earth path for the wiper motor is directed through the normally closed contacts of relay 2 and the connection at relay 3 socket to the wiper earth point. Depressing the wash/wipe switch the screen wash pump stops immediately. For the wiper system control unit maintains the 12 volt positive supply at terminal 2 for a further five seconds causing the wiper motor to complete approximately five cycles. The wiper cycle ends with the wiper blades in the parked position (details of which are shown in the diagrams for the OFF position).

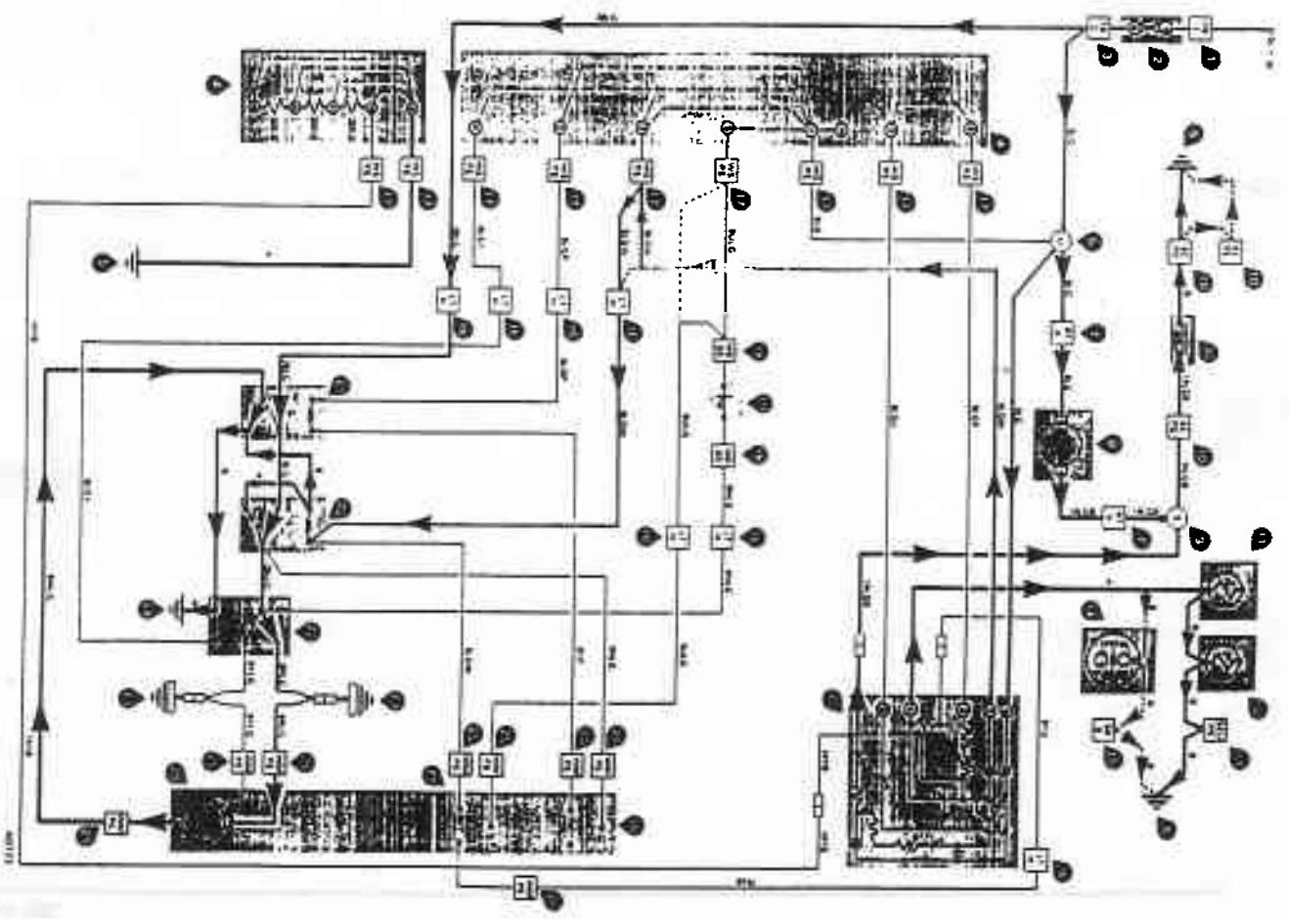

Windscreen wipers and washers

Cars from vehicle identification number
SCAZS42A3FCX12001

Lucas screenwiper electronic control unit - To test
Rolls-Royce Silver Spirit, Silver Spur (including
division), Bentley Mulsanne (including Turbo) and
Bentley Eight.

It must be emphasised that the following procedure is
only applicable to cars from vehicle identification
number *SCAZS42A3FCX12001* fitted with a four
position intermittent wiper circuit.

During the test it is necessary to use a voltmeter.

Do not use a test lamp. The use of a test lamp will
result in damage to the electronic control unit.

Also, throughout the test procedure, ensure that a
constant 12.5 dc voltage is maintained.

Where reference is made to the relay energizing
or de-energizing it is indicated by the sound of a click
or if held, by a small vibration.

1. Carry out the usual workshop safety precautions.
2. Disconnect and remove the control unit from its location.
3. Connect a 12.5 volt supply to the control unit; positive connection to terminal 1, negative connection to terminal 4.
4. Connect a voltmeter to the unit as shown in figure M9-1 (i.e. positive connection to terminal 1, negative connection to terminal 2). Ensure that the voltmeter is set on the 12 volt dc scale.
5. Using a spare 12 volt relay connect the relay windings (terminals 85 and 86) to terminals 2 and 4 of the control unit (see fig. M9-1).
6. Connect a length of cable between terminals 4 and 6 of the control unit.

After a period of between 0.5 seconds and 1 second the relay should energize.

Check to ensure that the voltage reading does not exceed 1 volt.

7. Remove the cable from between terminals 4 and 6 and immediately check that there is a delay of between 4 seconds and 6 seconds before the relay de-energizes.

Check that the voltmeter does not read less than 12.5 volts.

8. Connect a $1K\Omega$ resistor between terminals 4 and 8 of the control unit. Then, connect a length of cable between terminals 3 and 5, ensure that the relay energizes.

Check that the voltmeter reading does not exceed 1 volt.

9. Connect a cable between terminals 1 and 7 and ensure that immediately the connection is made the relay de-energizes.

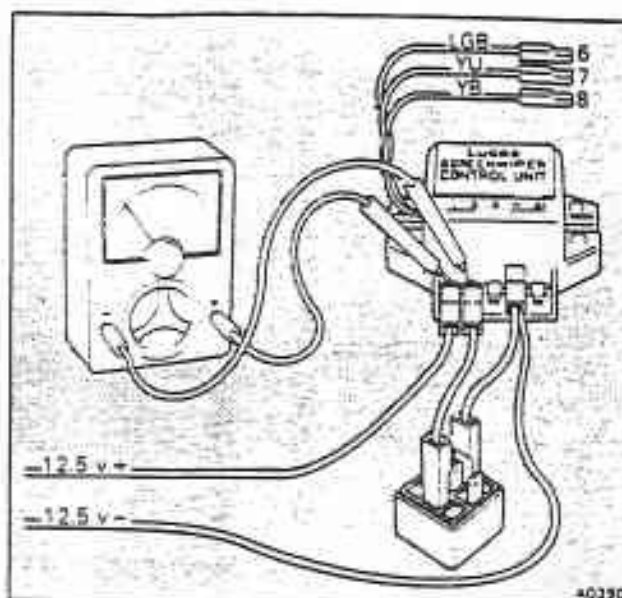

Fig. M9-1 Testing the electronic control unit

Check that the voltage reading is not less than 12.5 volts.

After a delay period of between 2½ and 3½ seconds ensure that the relay energizes. Check that the voltage reading does not exceed 1 volt.

10. If the test proves satisfactory the fault lies elsewhere within the circuit. Therefore the fault must be corrected before fitting the control unit to the car.

If the test did not prove satisfactory ensure that the remainder of the circuit is functioning correctly before fitting a new control unit to the car.